

FABRICACIÓN Y COMERCIALIZACIÓN DE HERRAJES S.A.

FCH

ARTICULOS DESTACADOS

Nuevos productos para sumar a tu negocio



ART. PS-L1

Pinches de seguridad



ART. KPP

Kits para puertas plegables



ART. CON-45-D

Linea tirantería y madera



ART. i-1730-3 / i-1730-7

Torniquetes y accesorios rurales



Consultá disponibilidad
y bonificaciones



WWW.FCHSA.COM.AR



[fchsa_herrajesforjados](https://www.instagram.com/fchsa_herrajesforjados)



LISTA DE PRECIOS Nº 95

VIGENCIA DESDE EL 01 DE JUNIO DE 2026

ARTICULOS NUEVOS

Panama 5945 (1682) M. Coronado-Pci. Bs. As.
Tel. y Fax 4751-1533 / 9034 - info@fchsa.com.ar

NUEVOS

TORNIQUETES

ART	MEDIDA	PLANCH.	PERNO	TERM.	P. UNI.	X CAJA
I-1730-3	N*3	32X1,6	Ø 11,2	Zincado	\$ 2.425,00	100
I-1730-7	N*7	30X1,9	Ø 14	Dracumet	\$ 4.620,00	100

CONSULTAR POR CANTIDAD



I-1730-3



I-1730-7

CONCERTINA

ART	DIAMETRO	CANT. DE VTAS	COBERTUR A	CLIPS	CLIPS	X CAJA
CON-45-D	45	55	10 MTS	3	USD 46,20	1

CONSULTAR POR CANTIDAD



CON-45-D



RESISTENCIA Y CALIDAD EN CADA DETALLE



**RESISTENCIA
DE ALTA CALIDAD**



**MATERIALES
DE PRIMERA**



**MÁXIMA
DURABILIDAD**



**FÁCIL
INSTALACIÓN**

FABRICACIÓN Y COMERCIALIZACIÓN DE HERRAJES S.A.

FCH



INFORMACIÓN COMERCIAL



Calidad industrial para uso intensivo.



DATOS BANCARIOS



BANCO BBVA



TITULAR FERNANDO EZEQUIEL CUELLI



CUIT 23-31374799-9



CBU 0170 1513 4000 0003 8296 73



ALIAS FCH.HERRAJES



TIPO DE CUENTA CAJA DE AHORRO EN PESOS



BONIFICACIONES



Descuentos especiales para compras por volumen



CONDICIONES COMERCIALES



ENTREGAS

A convenir según zona. Consultar plazos.



FORMA DE PAGO

Contado / Transferencia Consultar otras opciones.



PRECIOS

Disponibles en nuestra página.



VALIDEZ

Lista vigente en nuestra página.



¿DÓNDE ESTAMOS?



Panama 5945,
(1683) Martín Coronado,
Bs. As., Argentina

Administración



+54 9 11 2575-6618
info@fchsa.com.ar

Ventas



+54 9 11 3878-8893
gerente@fchsa.com.ar



www.fchsa.com.ar

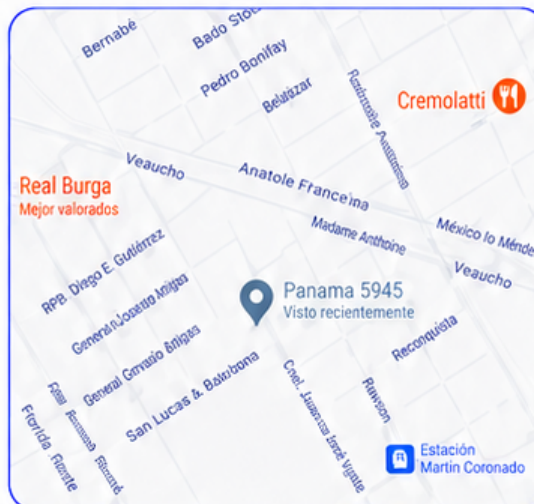

ESCANEÁ Y LLEGÁ a nuestra ubicación



Abrir en Google Maps



Productos diseñados para máxima resistencia y durabilidad.



Panama 5945 (1682) M. Coronado-Pci. Bs. As.
Tel. y Fax 4751-1533 / 9034 - info@fchsa.com.ar

LISTA DE PRECIOS N° 95

VIGENCIA DESDE EL 01 DE JUNIO DE 2026

HERRAJES FORJADOS

BISAGRAS

BISAGRAS DE AMURAR

ART	MEDIDA	PLANCHUELA	PERNO	P. UNI.	X CAJA
1525-10	10 cm.	32x3 mm.	Ø 9 1/2	\$ 2.715,50	24
1525-13	13 cm.	32x3 mm.	Ø 9 1/2	\$ 2.950,20	24
1525-20	20 cm.	32x3 mm.	Ø 9 1/2	\$ 3.445,65	18
1525-25	25 cm.	32x3 mm.	Ø 9 1/2	\$ 3.802,05	18
1525-18-R	18 cm.	38x5 mm.	Ø 12	\$ 6.432,00	10
1525-30	30 cm.	38x5 mm.	Ø 12	\$ 7.917,30	8

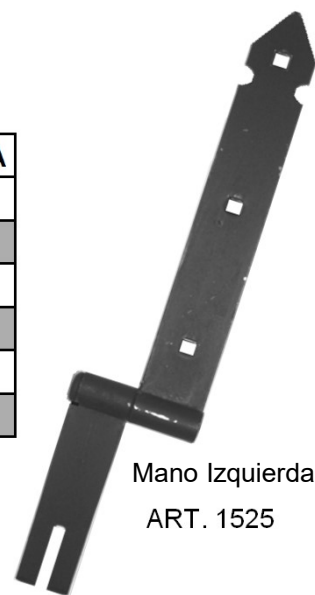

Mano Izquierda
ART. 1525

BISAGRAS DE ATORNILLAR

ART	MEDIDA	PLANCHUELA	PERNO	P. UNI.	X CAJA
1527-10	10 cm.	32x3	Ø 9 1/2	\$ 3.005,45	24
1527-10-AC	10 cm.	32x3	Ø 9 1/2	\$ 3.005,45	24
1527-13	13 cm.	32x3	Ø 9 1/2	\$ 3.240,15	24
1527-13-AC	13 cm.	32x3	Ø 9 1/2	\$ 3.240,15	24
1527-20	20 cm.	32x3	Ø 12	\$ 3.735,60	18
1527-20-AC	20 cm.	32x3	Ø 12	\$ 3.735,60	18
1527-25	25 cm.	32x3	Ø 12	\$ 4.092,00	18
1527-18-R	18 cm.	38x5	Ø 12	\$ 6.732,45	10
1527-30	30 cm.	38x5	Ø 12	\$ 9.518,35	8



ART. 1527



ART. 1527-AC



Panama 5945 (1682) M. Coronado-Pci. Bs. As.
Tel. y Fax 4751-1533 / 9034 - info@fchsa.com.ar

LISTA DE PRECIOS N° 95

VIGENCIA DESDE EL 01 DE JUNIO DE 2026

HERRAJES FORJADOS

BISAGRAS

BISAGRAS CON BULON PARA POSTE

ART	MEDIDA	PLANCHUELA	PERNO	P. UNI.	X CAJA
1528-10	10 cm.	32X3 mm.	Ø 9 1/2	\$ 4.919,00	24
1528-13	13 cm.	32X3 mm.	Ø 9 1/2	\$ 5.153,70	24
1528-20	20 cm.	32X3 mm.	Ø 9 1/2	\$ 5.649,15	18
1528-25	25 cm.	32X3 mm.	Ø 9 1/2	\$ 6.005,55	18
1528-18-R	18 cm.	38X5 mm.	Ø 12	\$ 9.196,65	10
1528-30	30 cm.	38X5 mm.	Ø 12	\$ 10.796,20	8



ART. 1528
Mano Derecha

TODAS LAS BISAGRAS CON PERNO DE 22 CM DE LARGO CON ROSCA DE 15 CM

BISAGRAS DOBLE ALA

ART	MEDIDA	PLANCHUELA	PERNO	P. UNI.	X CAJA
1529-10	10 cm.	32X3 mm.	Ø 9 1/2	\$ 3.034,15	24
1529-13	13 cm.	32X3 mm.	Ø 9 1/2	\$ 3.399,20	24
1529-20	20 cm.	32X3 mm.	Ø 9 1/2	\$ 4.706,55	20
1529-18-R	18 cm.	38X5 mm.	Ø 12	\$ 8.804,90	16



ART. 1529

ESCUADRAS PLANAS

ART	MEDIDA	PLANCHUELA	P. UNI.	X CAJA
1623-13	13x13 cm.	32X3 mm.	\$ 3.576,20	12
1623-20	20x20 cm.	32X3 mm.	\$ 4.795,00	12
1623-25	25x25 cm.	32X3 mm.	\$ 5.469,00	12

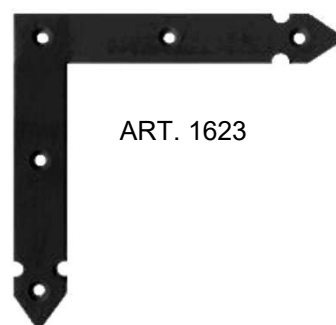

ART. 1623

BISAGRAS DOBLE ALA CARROCERA

ART	MEDIDA	PLANCHUELA	PERNO	P. UNI.	X CAJA
1564-10-SA	10 cm.	63x3 mm.	Ø 9 1/2	\$ 4.331,85	16
1564-13-SA	13 cm.	75x5 mm.	Ø 12	\$ 8.075,50	8
1564-10	10 cm.	63x3 mm.	Ø 9 1/2	\$ 4.394,85	16
1564-13	13 cm.	75x5 mm.	Ø 12	\$ 8.759,20	8



ART. 1564

HERRAJES FORJADOS

HERRAJES PARA BAUL

ART	MEDIDA	PLANCH.	DESCRIP.	TERM.	P. UNI.	X CAJA
1544	11 cm.	38x3 mm.	Porta Cand.	Pint.	\$ 3.688,40	8
1555	4 cm.	38x3 mm.	B. Baul	Pint.	\$ 2.671,40	24
1556	18 cm.	38x5 mm.	M. Baul	Pint.	\$ 5.589,25	12
1557-10	10 cm.	12x3 mm.	M. Puente	Pint.	\$ 904,05	50
1557-15	15 cm.	25x3 mm.	M. Puente	Pint.	\$ 1.019,70	50
1557-20	20 cm.	32x3 mm.	M. Puente	Pint.	\$ 2.073,65	24



ART. 1544

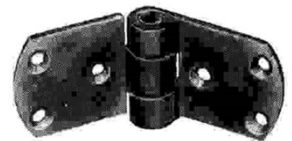

ART. 1555

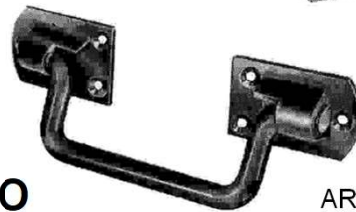

ART. 1556

HERRAJES PARA POSTIGO

ART	MEDIDA	PLANCH.	DESCRIP.	TERM.	P. UNI.	X CAJA
1530-T	10 cm.	19x5 mm.	Reten	Pint.	\$ 2.837,10	24
1530-T-Z	10 cm.	19x5 mm.	Reten	Zinc.	\$ 3.850,45	24

HERRAJES PARA PASAMANO

ART	PERNO	BASE	PERNO	TERM.	P. UNI.	X CAJA
1532-AT	6+4 cm.	38x3X60 mm.	Ø 11	Pint.	\$ 4.815,75	18
1532-AT-Z	6+4 cm.	38x3X60 mm.	Ø 11	ZINC.	\$ 6.183,45	18
1532-T	6+4 cm.	38x3X60 mm.	Ø 11	Pint.	\$ 4.424,90	18
1532-T-Z	6+4 cm.	38x3X60 mm.	Ø 11	ZINC.	\$ 5.565,85	18
1533-AT	6+4 cm.	38x3X60 mm.	Ø 11	Pint.	\$ 4.815,75	18
1533-AT-Z	6+4 cm.	38x3X60 mm.	Ø 11	ZINC.	\$ 6.183,45	18
1533-T	6+4 cm.	38x3X60 mm.	Ø 11	Pint.	\$ 4.424,90	18
1533-T-Z	6+4 cm.	38x3X60 mm.	Ø 11	ZINC.	\$ 5.565,85	18



ART. 1557

ART. 1557-20

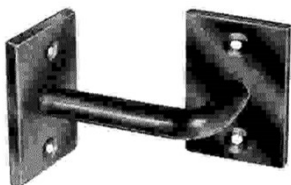

ART. 1532-AT



ART. 1532-T



ART. 1530-T

HERRAJES FORJADOS

Panama 5945 (1682) M. Coronado-Pci. Bs. As.
Tel. y Fax 4751-1533 / 9034 - info@fchsa.com.ar

ACCESORIOS PARA MARCO

ART	MEDIDA	CHAPA	DESCRIP.	P. UNI.	X CAJA
1534-L	15 cm.	0,9 mm.	G. Ond.	\$ 525,60	50
1534-R	15 cm.	0,9 mm.	G. Ond.	\$ 631,95	50

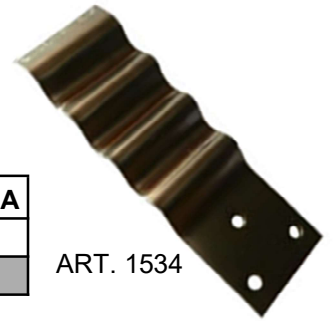

ART. 1534

MENSULAS DE ESTILO

ART	MEDIDA	PLANCH.	RIZO	P. UNI.	X CAJA
1620-15	15x12 cm.	19x5 mm.	12x3 mm.	\$ 4.014,30	12
1620-20	20x15 cm.	19x5 mm.	12x3 mm.	\$ 4.653,45	12
1620-25	25x20 cm.	19x5 mm.	12x3 mm.	\$ 5.542,60	12
1620-30	30x25 cm.	19x5 mm.	12x3 mm.	\$ 7.229,85	12
1620-40	40x30 cm.	25x5 mm.	19x5 mm.	\$ 11.081,75	6
1620-50	50x40 cm.	25x5 mm.	19x5 mm.	\$ 13.506,10	6
1620-70-A	70x50 cm.	32x3 mm.	19x5 mm.	\$ 15.131,15	6



ART. 1620

MENSULAS CON REFUERZO RECTO

ART	MEDIDA	PLANCH.	RZO.	P. UNI.	X CAJA
1620-R-15	15x12 cm.	19x5 mm.	12x3 mm.	\$ 3.442,60	12
1620-R-20	20x15 cm.	19x5 mm.	12x3 mm.	\$ 4.021,60	12
1620-R-25	25x20 cm.	19x5 mm.	12x3 mm.	\$ 4.890,70	12
1620-R-25-M	25x25 cm.	32x3 mm.	32x3 mm.	\$ 7.296,10	6
1620-R-30	30x25 cm.	19x5 mm.	12x3 mm.	\$ 6.235,60	12
1620-R-40	40x30 cm.	25x5 mm.	19x5 mm.	\$ 10.124,05	6
1620-R-50	50x40 cm.	25x5 mm.	19x5 mm.	\$ 12.649,20	6

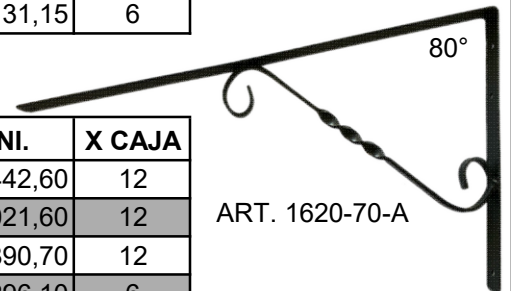

ART. 1620-70-A

MENSULA INVISIBLE

ART	MEDIDA	PERNO	Term.	P. UNI.	X CAJA
1620-I-20-Z	20 cm.	∅ 11	Zinc.	\$ 5.298,75	12

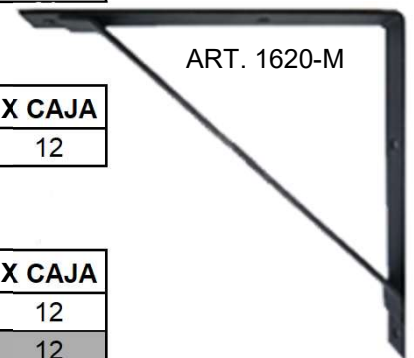

ART. 1620-M

ESCUADRAS

ART	MEDIDA	PLANCH.	Term.	P. UNI.	X CAJA
1621-2-Z	2,5x2,5 cm.	12x3 mm.	Zincado	\$ 629,20	12
1621-5-Z	5x5 cm.	12x3 mm.	Zincado	\$ 851,70	12
1621-7-Z	7,5x7,5 cm.	12x3 mm.	Zincado	\$ 1.142,70	12
1621-10	10x10 cm.	19x5 mm.	Pintado	\$ 2.116,20	12
1621-15	15x12 cm.	19x5 mm.	Pintado	\$ 2.639,05	12
1621-20	20x15 cm.	19x5 mm.	Pintado	\$ 3.144,70	12



ART. 1621



ART. 1620-I

HERRAJES FORJADOS

Panama 5945 (1682) M. Coronado-Pci. Bs. As.
Tel. y Fax 4751-1533 / 9034 - info@fchsa.com.ar

PASADORES CON PUENTE SOLDADO

ART	MEDIDA	BASE	PASADOR	TERM.	P. UNI.	X CAJA
1543-10	10 cm.	32x3x60 mm.	12X6	Pintado	\$ 3.312,45	24
1543-10-P	10 cm.	32x3x60 mm.	12X6	Pintado	\$ 3.312,50	24
1543-15	15 cm.	32x3x90 mm.	12X6	Pintado	\$ 3.718,80	24
1543-15-P	15 cm.	32x3x90 mm.	12X6	Pintado	\$ 4.092,55	24
1543-20	20 cm.	32x3x140 mm.	12X6	Pintado	\$ 5.243,10	18
1543-20-P	20 cm.	32x3x140 mm.	12X6	Pintado	\$ 5.645,60	18

ART. 1543-P



ART. 1543



PASADORES CON BASE EN "U"

ART	MEDIDA	BASE	PASADOR	TERM.	P. UNI.	X CAJA
1565-10	7 cm.	32x3x40 mm.	12X6	Pintado	\$ 2.472,80	24
1565-10-P	7 cm.	32x3x40 mm.	12X6	Pintado	\$ 2.837,90	24
1565-15	10 cm.	32x3x50 mm.	12X6	Pintado	\$ 2.675,60	24
1565-15-P	10 cm.	32x3x50 mm.	12X6	Pintado	\$ 3.101,50	24
1565-20	20 cm.	32x3x105 mm.	12X6	Pintado	\$ 3.735,45	18
1565-20-P	20 cm.	32x3x105 mm.	12X6	Pintado	\$ 4.065,75	18

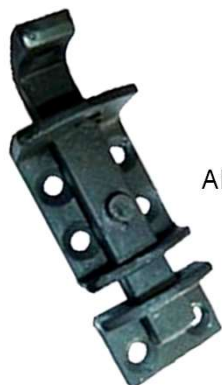

ART. 1565

HERRAJES FORJADOS

Panama 5945 (1682) M. Coronado-Pci. Bs. As.
 Tel. y Fax 4751-1533 / 9034 - info@fchsa.com.ar

PASADORES AL PISO (S/PTE. DE ATORNILLAR)

ART	MEDIDA	BASE	PASADOR	TERM.	P. UNI.	X CAJA
1535-25	25 cm.	32x3x100 mm.	Ø 9 1/2	Pintado	\$ 3.969,25	18
1535-30	30 cm.	38x3x120 mm.	Ø 12	Pintado	\$ 5.361,25	12
1541-15	15 cm.	32x3x90 mm.	Ø 9 1/2	Pintado	\$ 3.580,75	24
1541-30	30 cm.	38x3x150 mm.	Ø 11	Pintado	\$ 5.674,45	20
1541-40	40 cm.	50x3x200 mm.	Ø 16	Pintado	\$ 11.937,65	6
1541-50	50 cm.	50x3x270 mm.	Ø 16	Pintado	\$ 15.074,60	6



Pasador de Piso con porta candado + 10 %



ART. 1541

PUENTES PARA ATORNILLAR AL MARCO

ART	PLANCH.	PUENTE PARA	TERM.	P. UNI.	X CAJA
1535-25-PUE	32x3 mm.	1535-25	Pintado	\$ 1.019,60	12
1535-30-PUE	38x3 mm.	1535-30	Pintado	\$ 1.066,40	12
1541-15-PUE	32x3 mm.	1541-15	Pintado	\$ 1.237,85	12
1541-30-PUE	38x3 mm.	1541-30	Pintado	\$ 1.381,15	12
1541-40-PUE	50x5 mm.	1541-40/50	Pintado	\$ 2.076,65	12
1540-PORT	32x5 mm.	PUENTE PORTA CAND.	Pintado	\$ 1.089,75	12



ART. 1541-PUE



ART. 1540-PORT



ART. 1535-PUE

CERROJOS

ART	MEDIDA	PLANCH.	PASADOR	TERM.	P. UNI.	X CAJA
1540-15	15 cm.	32x3x90 mm.	Ø 9 1/2	Pintado	\$ 5.117,95	18
1540-20	20 cm.	38x3x150 mm.	Ø 11	Pintado	\$ 7.079,85	10
1540-30	30 cm.	50x3x200 mm.	Ø 16	Pintado	\$ 15.729,70	4
1540-40	40 cm.	50x3x270 mm.	Ø 16	Pintado	\$ 17.295,35	4

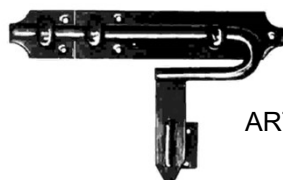

ART. 1540

HERRAJES FORJADOS

Panama 5945 (1682) M. Coronado-Pci. Bs. As.
 Tel. y Fax 4751-1533 / 9034 - info@fchsa.com.ar

GANCHO CONTRAVIENTO



ART. 1622

ART	MEDIDA	BASE	PERNO	TERM.	P. UNI.	X CAJA
1622-10	10 cm.	32X3x50 mm.	Ø 8	Pintado	\$ 3.647,33	12
1622-10-Z	10 cm.	32X3x50 mm.	Ø 8	Zincado	\$ 5.042,39	12
1622-15	15 cm.	32X3x50 mm.	Ø 8	Pintado	\$ 3.810,71	10
1622-15-Z	15 cm.	32X3x50 mm.	Ø 8	Zincado	\$ 5.365,87	10

ALDABAS DE HIERRO FORJADO



ART. 1624

ART	MEDIDA	PLANCH.	P. UNI.	X CAJA
1624-6	6 cm.	12X3 mm.	\$ 1.527,45	24
1624-12	12 cm.	25X3 mm.	\$ 2.730,70	18

MANIJONES

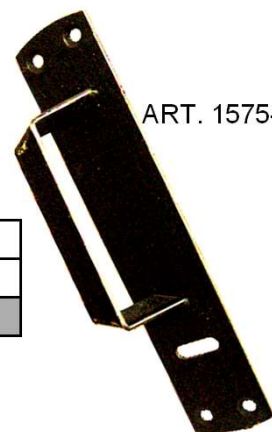

ART. 1575-L

ART	ALTA	BASE	MANO	TERM.	P. UNI.	X CAJA
1575-L	25 cm.	50X3 mm.	I Y D	Pintado	\$ 8.377,55	8
1575-L-Z	25 cm.	50X3 mm.	I Y D	Zincado	\$ 11.545,25	8

PORTA TRANCA

ART	MEDIDA	PLANCH.	DESCRIPCOPN	TERM.	P. UNI.	X CAJA
1580-32		32x5 mm.	P/TRANCA DE 50X32	Pintado	\$ 2.357,65	24
1580-25		32x5 mm.	P/TRANCA DE 50X25	Pintado	\$ 2.357,65	24
1580-7		32x5 mm.	P/TRANCA DE 50X7	Pintado	\$ 2.357,65	24
1580-TRA	100 cm.	50X5 mm.	TRANCA DE 1 MT.	Pintado	\$ 17.682,05	6
1581		32X3 mm.	CON PERNO Y CAND.	Pintado	\$ 6.882,80	12

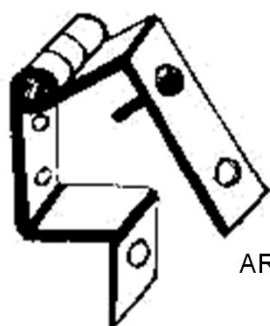

ART. 1581



ART. 1580

ACCESORIOS RURALES

Panama 5945 (1682) M. Coronado-Pci. Bs. As.
 Tel. y Fax 4751-1533 / 9034 - info@fchsa.com.ar

BISAGRAS PARA TRANQUERA

ART	MEDIDA	PLANCH.	PERNO	ABERT.	P. UNI.	X CAJA
1700-18	18 cm.	50x3 mm.	14	1 3/4"	\$ 13.489,10	12
1700-20	20 cm.	50x5 mm.	16	2 1/2"	\$ 17.458,00	12
1700-25	25 cm.	50x5 mm.	16	3"	\$ 19.049,95	10
1700-30	30 cm.	50x5 mm.	19	3"	\$ 24.344,90	8
1700-40	40 cm.	63x6 mm.	22	3"	\$ 50.082,70	4

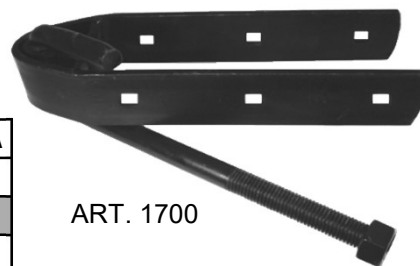

ART. 1700

AROS

ART	MEDIDA	PLANCH.	ABERT.	NRO.	P. UNI.	X CAJA
1710-27	27 cm.	25x5 mm.	2"	1	\$ 6.821,70	6
1710-29	29 cm.	38x5 mm.	3"	DOBLE	\$ 9.658,95	6
1710-30	30 cm.	25x5mm.	2"	2	\$ 7.478,15	6



ART. 1710-29



ART. 1710

PASADOR DE PUERTA PARA MANGA

ART	MEDIDA	PLANCH.	PERNO	P. UNI.	X CAJA
1720-11	11 cm.	50X5 mm.	Ø11	\$ 6.638,25	6
1720-17	17 cm.	50X5 mm.	Ø 16	\$ 10.195,75	6
1720-19	19 cm.	50X5 mm.	Ø 19	\$ 12.299,00	6

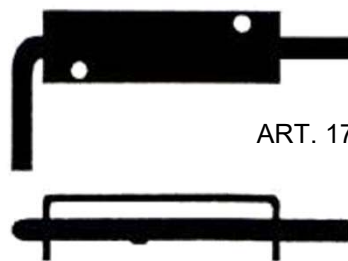

ART. 1720

TORNIQUETES

ART	MEDIDA	PLANCH.	PERNO	TERM.	P. UNI.	X CAJA
1730-6	N*6	32X5	Ø 14	Pintado	\$ 5.064,70	24
1730-6-Z	N*6	32X5	Ø 14	Zincado	\$ 8.182,80	24
1730-8	N*8	38X5	Ø 16	Pintado	\$ 6.344,10	24
1730-8-Z	N*8	38X5	Ø 16	Zincado	\$ 10.560,60	24

ART. 1730



ART. 1705-R



ART. 1705-T

BISAGRAS

ART	MEDIDA	PLANCH.	PERNO	TIPO	P. UNI.	X CAJA
1705-D	19 cm.	38x5	Ø 12	VOLCABLE	\$ 8.716,55	8
1705-R	19 cm.	38x5	Ø 12	D. RECTA	\$ 7.675,30	10
1705-T	25 cm.	50x5	Ø 12	B. "T"	\$ 12.731,40	12



ART. 1705-D

HERRAJES DE ESTILO

Panama 5945 (1682) M. Coronado-Pci. Bs. As.
 Tel. y Fax 4751-1533 / 9034 - info@fchsa.com.ar

MANIJONES Y MANIJAS

ART	DESCRIPCION	P. UNI.	X CAJA
1560	MEDIA MANIJA DE EST. CRUZ	\$ 8.565,60	6
1561	MANIJA BALANCIN DE EST. GIRATORIA	\$ 8.821,85	6
1562	BOCALLAVE DE ESTILO	\$ 1.127,65	12
1563	MANIJA DOBLE BALANCIN	\$ 13.260,65	6
1566	TIRADOR DE ESTILO	\$ 3.562,25	12

ART. 1562

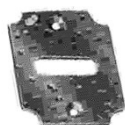

ART. 1566

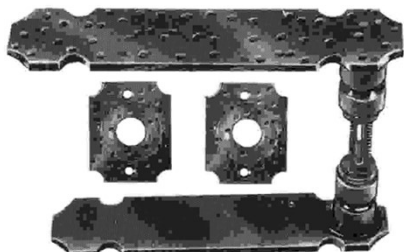

ART. 1563



ART. 1560

HERRAJES P/HERRERO

Panama 5945 (1682) M. Coronado-Pci. Bs. As.
Tel. y Fax 4751-1533 / 9034 - info@fchsa.com.ar

BISAGRAS DE HERRERO PARA AMURAR

ART	ALA 1	PATA	PERNO	P. UNI.	X CAJA
1524-L1	32x3x15	25x3	Ø 9 1/2	\$ 2.294,10	24
1524-L4	32x3x40	25x3	Ø 9 1/2	\$ 2.495,85	24
1524-R1	32x5x15	32x5	Ø 12	\$ 3.984,00	24
1524-R12	32x5x40	32x5	Ø 12	\$ 4.185,75	24
1524-R2	38x5x15	32x5	Ø 12	\$ 4.230,80	24
1524-R22	38x5x40	32x5	Ø 12	\$ 4.450,10	24
1524-R5	50x5x15	38x5	Ø 12	\$ 5.244,70	24
1524-R6	50x5x40	38x5	Ø 12	\$ 5.571,70	24

PATA



ALA 1

ART. 1524

BISAGRAS DOBLE ALA HERRERO P/SOLDAR

ART	ALAS	PERNO	P. UNI.	X CAJA
1523-L	32x3x15	Ø 9 1/2	\$ 1.829,40	24
1523-L2	32x3x40	Ø 9 1/2	\$ 2.194,45	24
1523-R1	32x5x15	Ø 12	\$ 2.733,00	24
1523-R12	32x5x40	Ø 12	\$ 3.107,65	24
1523-R2	38x5x15	Ø 12	\$ 3.115,10	24
1523-R22	38x5x40	Ø 12	\$ 3.522,35	24
1523-R3	50x5x15	Ø 12	\$ 4.097,10	24
1523-R4	50x5x40	Ø 12	\$ 4.751,05	24



ART. 1523

CAJAS PARA CERRADURA

ART	MEDIDA	DESCRIPCION	P. UNI.	X CAJA
1800-25	1"	DE 17X7,5 CM	\$ 3.993,65	8
1800-32	1 1/4"	DE 17X7,5 CM	\$ 4.777,90	8



ART. 1800

CAJAS PARA CERROJO

ART	MEDIDA	DESCRIPCION	P. UNI.	X CAJA
1810-25	1"	DE 10X7,5 CM	\$ 2.949,60	14
1810-32	1 1/4"	DE 10X7,5 CM	\$ 3.421,40	14



ART. 1810

**ACC. P/ CORTINAS DE
 ENROLLAR Y REGULABLES**

ENROLLADORES

ART	DESCRIPCION	P. UNI.	X CAJA
2000-4-G	E. de 4 mts. Galvanizado	\$ 7.487,94	18
2000-4-ZB	E. de 4 mts. pintado epoxi con buche	\$ 32.881,40	6
2000-6-G	E. de 6 mts. Galvanizado	\$ 10.153,74	12
2000-6-ZB	E. de 6 mts. pintado epoxi con buche	\$ 38.602,90	6
2000-8-Z	E. de 8 mts. pintado epoxi	\$ 43.488,05	6
2000-8-ZB	E. de 8 mts. pintado epoxi con buche	\$ 52.183,95	6
2000-10-Z	E. de 10 mts. pintado epoxi	\$ 67.498,50	6



ART. 2000



ART. 2000-8/10

POLEAS

ART	MEDIDA	P. UNI.	X CAJA
2002-P	Corazón de plástico p/eje octog. de 70 mm.	\$ 1.281,73	10



ART. 2002

ACC. P/ CORTINAS DE ENROLLAR Y EGULABLES

ACCESORIOS

ART. 2010-E

ART	DESCRIPCION	P. UNI.	X CAJA
2010-E	Gpa. Giratoria. estampada de chapa	\$ 664,42	12
2010-R	Gpa. Giratoria. Ref. planch. de 25 x 5 mm.	\$ 1.460,64	12
2011	Gpa. para rulemán planch. de 25 x 6 mm.	\$ 1.376,47	12
2012	Ruleman	\$ 9.411,30	12
2013-L	Punta de eje liviana	\$ 314,73	12
2013-R	Punta de eje reforzada	\$ 659,97	12
2014-G	Pasacinta sple. c/rodillo de madera. Galv.	\$ 698,41	12
2015-G	Pasacinta doble c/rodillo de madera. Galv.	\$ 978,71	12
2017-4	Caja de 4 mts. de madera	\$ 2.410,10	20
2017-6	Caja de 6 mts. de madera	\$ 3.010,50	20
2017-8	Caja de 8 mts. de madera	\$ 4.358,25	10
2018-60-P	Taco de plástico para eje de 60 mm.	\$ 944,90	12
2018-70-P	Taco de plástico para eje de 70 mm.	\$ 1.383,90	12
2019-G	Tope de hierro Galvanizado	\$ 742,83	50
2019-P	Tope de plastico blanco	\$ 93,24	50
2020-3	Reductor de 1 x 3 de chapa c/Reduccion en H°	\$ 165.289,20	1
2020-3-P	Reductor de 1 x 3 de chapa c/Reduccion en Ny	\$ 101.787,00	1
2020-4	Reductor de 1 x 4 de chapa c/Reduccion en H°	\$ 217.747,55	1
2021	Grampa para Reductor	\$ 8.972,10	1
2040-70-C	Capuc. p/eje de 70 mm. Pint. Epoxi	\$ 14.248,90	1
2040-P20-C	P. N°20 c/capuc. p/eje de 70 mm. Pint. Epoxi	\$ 27.578,45	1
2040-P23-C	P. N°23 c/capuc. p/eje de 70 mm. Pint. Epoxi	\$ 35.422,45	1
2040-P23-C	P. N°23 c/capuc. p/eje de 70 mm. Pint. Epoxi	\$ 35.422,45	1



ART. 2010



ART. 2011



ART. 2012



ART. 2013



ART. 2020



ART. 2014-G



ART. 2015-G



ART. 2019-G



ART. 2040-70-C



ART. 2018



ART. 2019-P

ACC. P/ CORTINAS DE ENROLLAR Y EGULABLES

HERRAJES PARA CORTINAS REGULABLES

ART. 2023

ART	DESCRIPCION	P. UNI.	X CAJA
2022	Costanero	\$ 509,05	50
2023	Fleje (el metro)	\$ 16.128,15	25
2024	Hebilla c/chicote	\$ 1.908,85	24
2026	Tubito	\$ 610,00	50
2027	Bisagra	\$ 1.908,85	24
2028-40	Rodillo de 40 mm. de madera	\$ 7.529,05	6
2028-60	Rodillo de 60 mm. de madera	\$ 11.795,50	6



ART. 2027



ART. 2028-40



ART. 2028-60

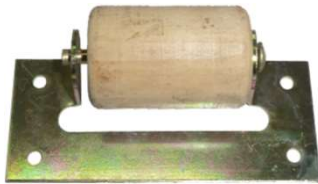

ART. 2024



CINTAS

ART	DESCRIPCIÓN	P. UNI.	X CAJA
2005-1	Cta p/cortina N°1 x mt. %60 Alg./ %40 Ny.	\$ 535,60	50
2005-3	Cta p/cortina N°3 x mt. %100 Alg.	\$ 984,15	50

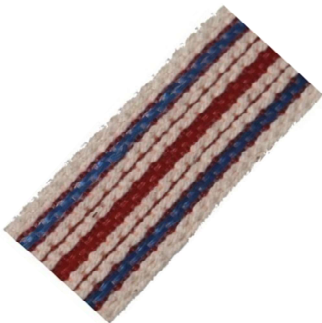

ART. 2005

BULONES Y TIRAFONDOS

Panama 5945 (1682) M. Coronado-Pci. Bs. As.
 Tel. y Fax 4751-1533 / 9034 - info@fchsa.com.ar

BULONES EMPAVONADOS

Con tuerca y arandela
 Precios por 100 un.

mm.		6,35	7,95	9,53
	pulg.	1/4	5/16	3/8
25	1"	32084,129		
32	1 1/4	33198,699	60844,119	
38	1 1/2	35408,193	64924,086	
44	1 3/4	37774,014	67800,833	
50	2"	44135,702	72446,567	101745,127
56	2 1/4	42420,411	76780,973	
63	2 1/2	45264,675	80076,621	112144,325
69	2 3/4	47198,095	84346,091	
75	3"	50420,642	86826,265	124540,582
81	3 1/4	53180,324	91413,783	
90	3 1/2	54744,230	96010,100	135875,032
100	4"	59186,268	102639,967	145738,294
113	4 1/2		122028,133	180265,466
125	5"		135246,586	187901,607
140	5 1/2		148940,769	210411,497
153	6"		160631,204	236127,031
178	7"		174054,708	248384,528
200	8"			
Aran. Emp. x kg.		27768,163	21071,637	24761,373
Tca. Emp. x 100		9572,454	21071,637	24761,373

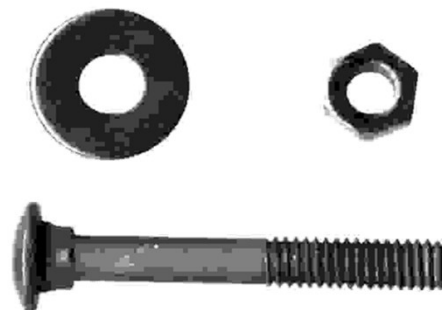

TIRAFONDOS ZINCADOS

Precios por 100 un.

mm.		4,76	6,35	7,95
	pulg.	3/16	1/4	5/16
25	1"	\$ 12.011,539	\$ 9.733,649	\$ 11.803,571
32	1 1/4	\$ 14.533,518	\$ 10.893,411	\$ 18.028,632
38	1 1/2	\$ 16.209,891	\$ 11.939,293	\$ 20.587,552
44	1 3/4	\$ 17.243,408	\$ 13.893,923	\$ 22.179,613
50	2"	\$ 18.850,551	\$ 15.144,333	\$ 22.532,888
56	2 1/4	\$ 20.472,529	\$ 16.838,654	\$ 25.410,216
63	2 1/2	\$ 22.786,815	\$ 18.942,037	\$ 27.415,978
69	2 3/4	\$ 24.230,771	\$ 19.715,987	\$ 30.528,049
75	3"	\$ 25.546,156	\$ 21.784,502	\$ 32.780,180
81	3 1/4		\$ 24.343,422	\$ 38.051,408
90	3 1/2		\$ 26.435,180	\$ 41.363,361
100	4"		\$ 29.677,402	\$ 46.032,630
113	4 1/2		\$ 32.461,767	\$ 50.690,281
125	5"		\$ 35.587,783	\$ 56.210,197
Aran. Zinc x kg.		\$ 23.597,618	\$ 27.768,163	\$ 21.071,637
Tca. Zinc. X 100		\$ 3.528,616	9572,454	21071,637



SOPORTE PARA TECHO

ANGULOS PERFORADOS

Chapa Nº 13 (2,5 mm.)



ART.	MEDIDA			PRECIO x Unidad	CANTIDAD x PAQ.
	A	B	C		
AP-240	240	33	33	\$ 1.994,60	10
AP-190	190	33	33	\$ 1.803,70	10
AP-140	140	33	33	\$ 1.399,80	10
AP-120	120	33	33	\$ 1.164,70	10
AP-90	90	33	33	\$ 987,65	10
AP-70	70	33	33	\$ 782,90	10
AP-45	45	33	33	\$ 630,75	10

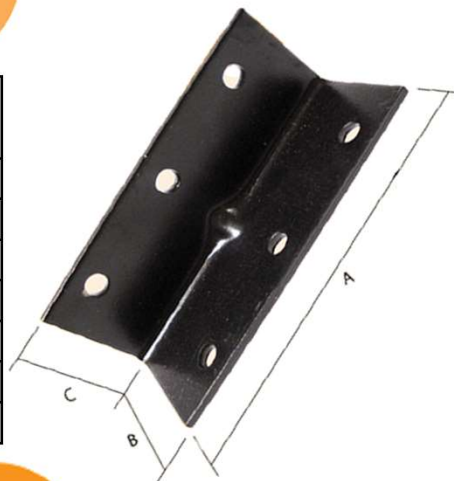

PLACAS DE EMPATILLADO

Chapa Nº 13 (2,5 mm)



ART.	MEDIDA		PRECIO x Unidad	CANTIDAD x PAQ.
	A	B		
PE-105	105	35	\$ 603,10	10
PE-135	135	45	\$ 1.208,95	10
PE-215	215	70	\$ 2.448,30	10
PE-145	145	70	\$ 1.601,75	10
PE-200	200	90	\$ 4.299,00	10
PE-240	240	115	\$ 6.409,75	10
PE-300	300	140	\$ 10.138,90	10



SOPORTE EN "L"

Chapa Nº 13 (2,5 mm.)



ART.	MEDIDA			PRECIO x Unidad	CANTIDAD x PAQ.
	A	B	C		
SL-45-70	70	70	45	\$ 1.297,45	10
SL-45-55	85	55	45	\$ 1.297,45	10
SL-35-50	50	50	35	\$ 852,10	10
SL-35-110	100	100	35	\$ 1.554,75	10
SL-70-110	100	100	70	\$ 2.860,50	10
SL-70-160	60	160	70	\$ 2.860,50	10
SL-70-70	70	70	70	\$ 1.839,70	10

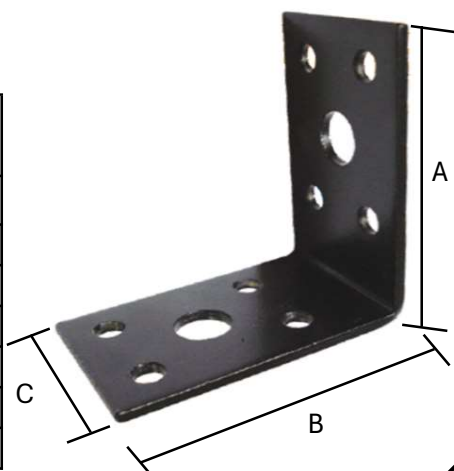

SOPORTE PARA TECHO

SOPORTES INDIVIDUALES 90°

Chapa N° 14 (2 mm)



ART.	MEDIDA			PRECIO x Unidad	CANTIDAD x PAQ.
	A	B	C		
SI-90-4	66	90	22	\$ 4.252,00	12
SI-90-5	66	115	22	\$ 5.081,90	12
SI-90-6	66	140	22	\$ 5.671,15	12

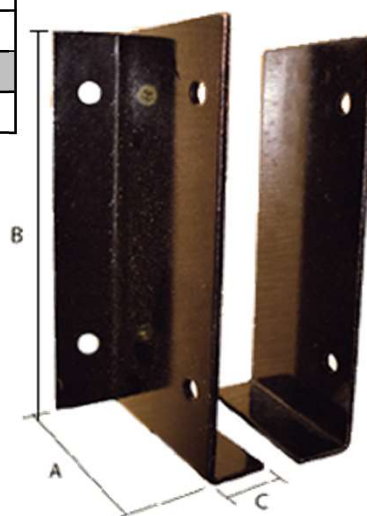

CAJAS INDIVIDUALES 90°

Chapa N° 14 (2 mm)



ART.	MEDIDA			PRECIO x Unidad	CANTIDAD x PAQ.
	A	B	C		
CI-4	66	90	22	\$ 4.252,00	12
CI-5	66	115	22	\$ 5.081,90	12
CI-6	66	140	22	\$ 5.671,15	12



SOPORTE PARA TECHO

SOPORTES CERRADOS 90°

Chapa N° 14 (2 mm)

ART.	MEDIDA			PRECIO x Unidad	CANTIDA D x PAQ.
	A	B	C		
SC-4	66	90	48	\$ 3.698,70	12
SC-5	66	115	48	\$ 4.661,40	12
SC-6	66	140	48	\$ 5.178,75	12
SC-6X3	66	140	70	\$ 6.072,25	12
SC-8X3	66	190	70	\$ 8.160,90	12

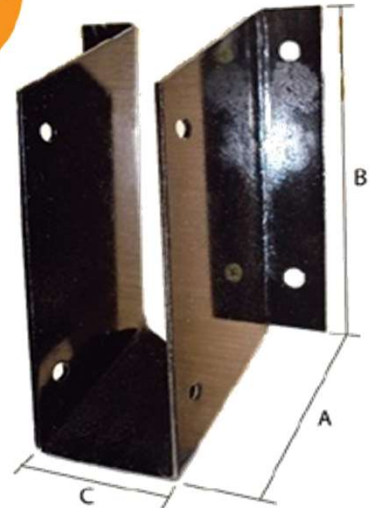

CAJAS CERRADAS 90°

Chapa N° 14 (2 mm)

ART.	MEDIDA			PRECIO x Unidad	CANTIDA D x PAQ.
	A	B	C		
CC-4	66	90	48	\$ 3.698,70	12
CC-5	66	115	48	\$ 4.661,40	12
CC-6	66	140	48	\$ 5.178,75	12
CC-6X3	66	140	70	\$ 6.072,25	12
CC-8X3	66	190	70	\$ 8.160,90	12

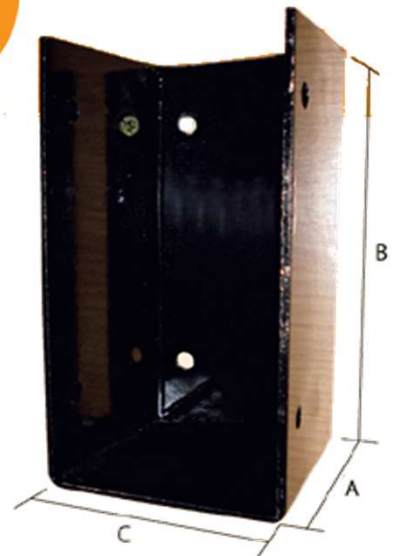

CUMBRERAS

Chapa N° 14 (2 mm)

ART.	MEDIDA			PRECIO x Unidad	CANTIDA D x PAQ.
	A	B	C		
C-30-150	145	150	30°	\$ 5.560,50	12
C-30-185	145	185	30°	\$ 6.318,50	12
C-45-150	145	150	45°	\$ 6.127,60	12
C-45-185	145	185	45°	\$ 7.463,75	12

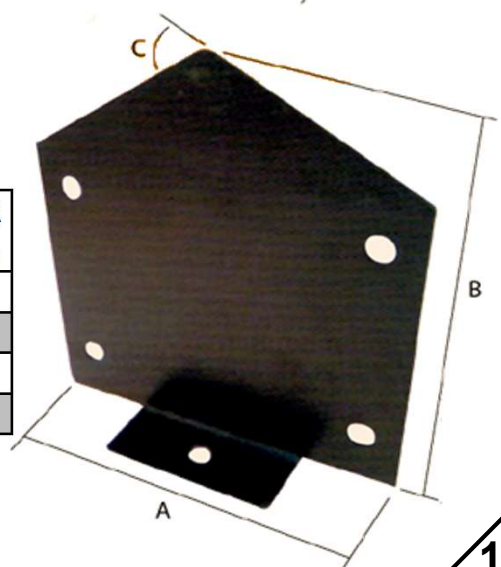

SOPORTE PARA TECHO

MENSULA PARA ESTANTE

Chapa N° 11 (3 mm.)



ART.	MEDIDA			PRECIO x PAR	CANTIDAD x PAQ.
	A	B	C		
M-190	190	90	22	\$ 7.347,60	12
M-300	300	135	22	\$ 18.642,80	12

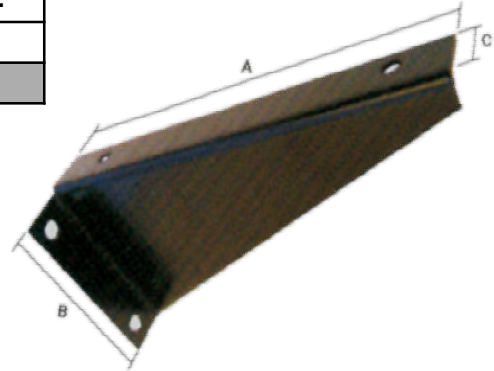

PLACA DE EMPATILLADO CON PESTAÑA

Chapa N° 11 (3 mm.)



ART.	MEDIDA			PRECIO x Unidad	CANTIDAD x PAQ.
	A	B	C		
PEP-4	20	90	300	\$ 6.534,25	10
PEP-5	20	115	350	\$ 8.802,70	10
PEP-6	20	140	400	\$ 11.948,10	10

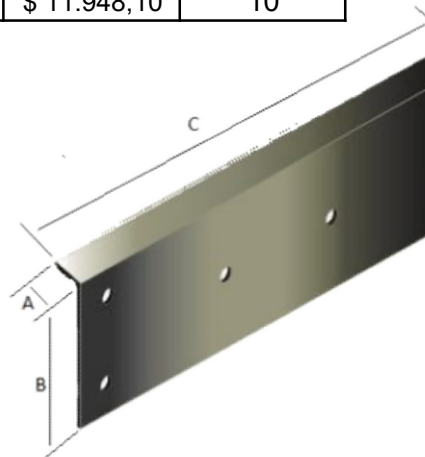

SOPORTE PARA TECHO

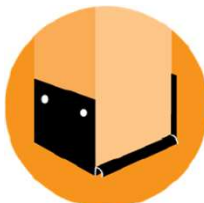

BASE DE COLUMNA

Chapa N° 11 (3 mm.)

ART.	MEDIDA				PRECIO x Unidad	CANTIDA D x PAQ.
	A	B	C	D		
BC-4X4	70	95	90	10	\$ 9.369,80	1
BC-5X5	100	120	115	10	\$ 12.576,10	1
BC-6X6	125	145	140	10	\$ 18.147,60	1
BC-6X7	115	162	140	10	\$ 20.936,15	1
BC-7X7	115	170	162	10	\$ 30.983,70	1

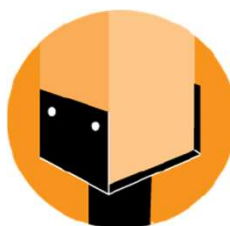
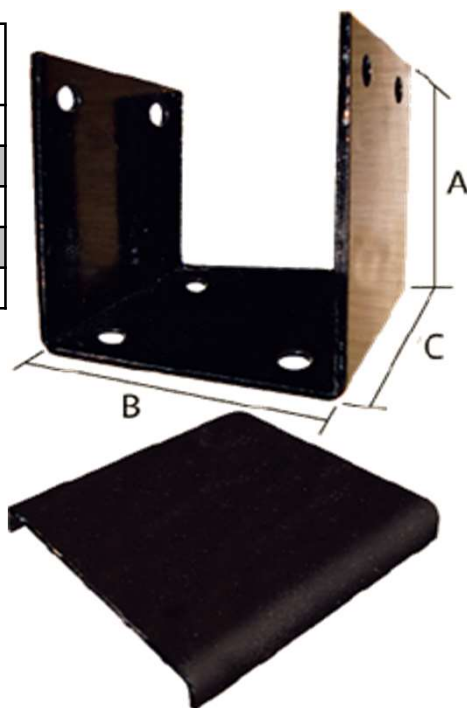

BASE DE COLUMNA CON PIE

Chapa N° 11 (3 mm.)

ART.	MEDIDA				PRECIO x Unidad	CANTIDA D x PAQ.
	A	B	C	D		
BCP-4X4	70	95	90	300	\$ 20.515,65	1
BCP-5X5	90	120	115	300	\$ 27.913,00	1
BCP-6X6	125	145	140	300	\$ 35.017,10	1
BCP-6X7	120	162	140	300	\$ 35.017,10	1
BCP-7X7	115	170	162	300	\$ 39.700,65	1

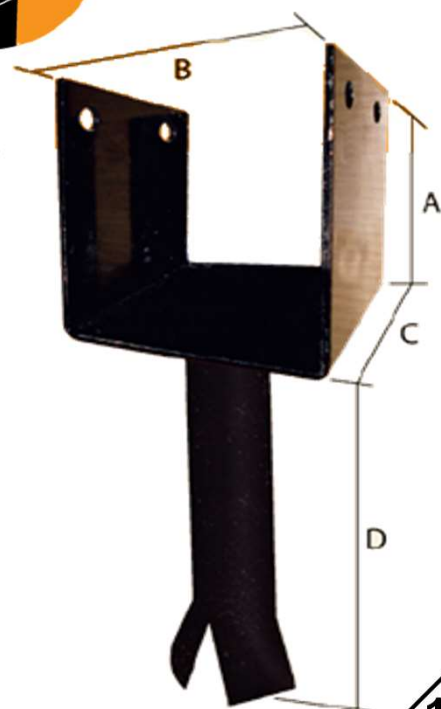



Panama 5945 (1682) M. Coronado-Pci. Bs. As.
Tel. y Fax 4751-1533 / 9034 - info@fchsa.com.ar

LISTA DE PRECIOS N° 95

VIGENCIA DESDE EL 01 DE JUNIO DE 2026

SOPORTE PARA TECHO

SOPORTE REDONDO 90°

Chapa N° 14 (2 mm)

ART.	MEDIDA		PRECIO x Unidad	CANTIDAD x PAQ.
	A	B		
SR-100	100	40	\$ 3.820,40	12
SR-130	130	40	\$ 4.069,40	12

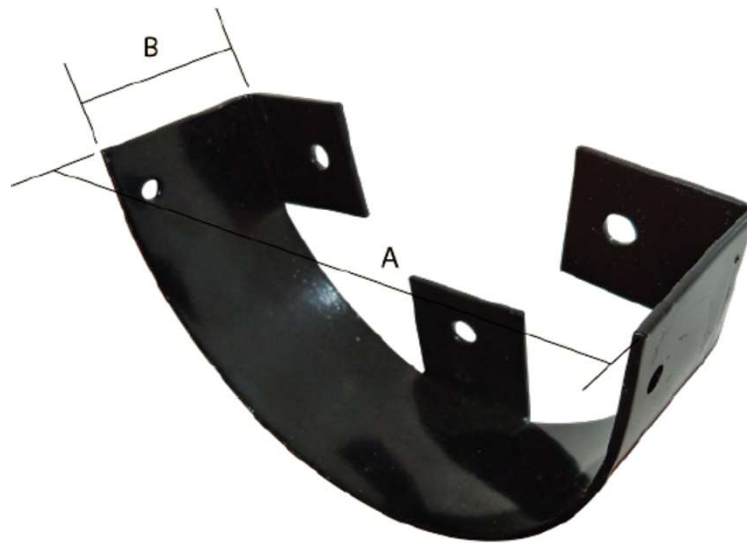

MATERIAL UTILIZADO

Soportes: Chapa N° 14 (2 mm)

Angulos y Sportes en " L " : Chapa N° 13 (2,5 mm.)

Base de Columna: Chapa N° 11 (3 mm.)

Los precios de la presente lista no incluyen I.V.A., se encuentran sujetos a variación sin previo aviso y registrarán al momento de la entrega sin excepción.

FICHAS Y B. MUNICION

FICHA PARA SOLDAR

ART.	DESCRIPCION	P. UNI.	X CAJA
FS-80X33	Ficha de 80 x 33 mm. Alas Largas	\$ 1.981,75	25
FS-80X8	Ficha de 80 x 8 mm. Alas Cortas	\$ 1.524,00	25
FS-60X33	Ficha de 60 x 33 mm. Alas Largas	\$ 1.658,40	25
FS-60X8	Ficha de 60 x 8 mm. Alas Cortas	\$ 1.220,30	25

ART. FS-80x33



ART. FS-80x8

FICHA PARA ATORNILLAR

ART.	DESCRIPCION	P. UNI.	X CAJA
FA-2X3X1.5	F. 2x3x1,5 mm. Rev. con tapa y perno M. H. P.	\$ 1.373,50	25
FAA-2X3X1.5	F. 2x3x1,5 mm. Rev. con tapa y perno M. Z. A.	\$ 1.648,20	25
FAD-2X3X1.5	F. 2x3x1,5 mm. Rev. con tapa y perno M. Z. D.	\$ 1.648,20	25
FA-2X5X1.5	F. 2x5x1,5 mm. Rev. con tapa y perno M. H. P.	\$ 1.551,50	25
FAA-2X5X1.5	F. 2x5x1,5 mm. Rev. con tapa y perno M. Z. A.	\$ 1.861,80	25
FAD-2X5X1.5	F. 2x5x1,5 mm. Rev. con tapa y perno M. Z. D.	\$ 1.861,80	25

ART. FAA x 3



ART. FAA x 5



MUNICION PARA SOLDAR ALA LARGA

ART.	DESCRIPCION	P. UNI.	X CAJA
MS-100X75	B. M. para soldar de 100 x 75 mm. Ala Larga	\$ 3.666,30	20
MS-75X75	B. M. para soldar de 75 x 75 mm. Ala Larga	\$ 2.942,45	20

ART. MS-100

MUNICION PARA SOLDAR ALA CORTA

ART.	DESCRIPCION	P. UNI.	X CAJA
MS-100X36	B. M. para soldar de 100 x 36 mm. Ala Corta	\$ 3.031,45	25
MS-75X36	B. M. para soldar de 75 x 36 mm. Ala Corta	\$ 2.315,05	25



MUNICION PARA ATORNILLAR

ART.	DESCRIPCION	P. UNI.	X CAJA
MA-100X75	B. M. p/at. de 100x75 mm. Ala L. Carp. Z. A.	\$ 4.044,20	20
MA-75X75	B. M. p/at. de 75x75 mm. Ala L. Carp. Z. A.	\$ 3.113,10	20



ART. MS-100

ART. MA-100



SEGURIDAD

PINCHES

ART.	BASE	ALTURA	CANTIDAD	P. UNI.	X CAJA
PS-L1	14x2,5 mm.	9 cm.	8 Flores x mt.	\$ 6.826,10	40



KIT PARA PUERTA CORREDIZA

ART.	MATERIAL	GUIA	P. UNI.	X CAJA	DESCRIPCION
KPG-2	32x5 mm.	2 mts	\$ 74.283,90	1	KIT GRANERO
KPG-3	32x5 mm.	3 mts	\$ 84.434,10	1	KIT GRANERO
CAR(EL PAR)	32x5 mm.		\$ 51.769,65	1	ACC. P/AGREGAR PUERTA
KPP-1	32x5 mm.	1 mt	\$ 98.685,50	1	PUERTA PLEGADIZA
KPP-2	32x5 mm.	1 mt	\$ 111.467,20	1	PUERTA PLEGADIZA
KPP-3	32x5 mm.	1 mt	\$ 124.248,90	1	PUERTA PLEGADIZA
KGD-2	32x5 mm.	2 mts	\$ 126.865,20	1	PUERTA SUPERPUESTA
KGD-3	32x5 mm.	3 mts	\$ 137.015,35	1	PUERTA SUPERPUESTA

