

FABRICACIÓN Y COMERCIALIZACIÓN DE HERRAJES S.A.

**FCH**

# NOVEDADES

## NUEVOS PRODUCTOS

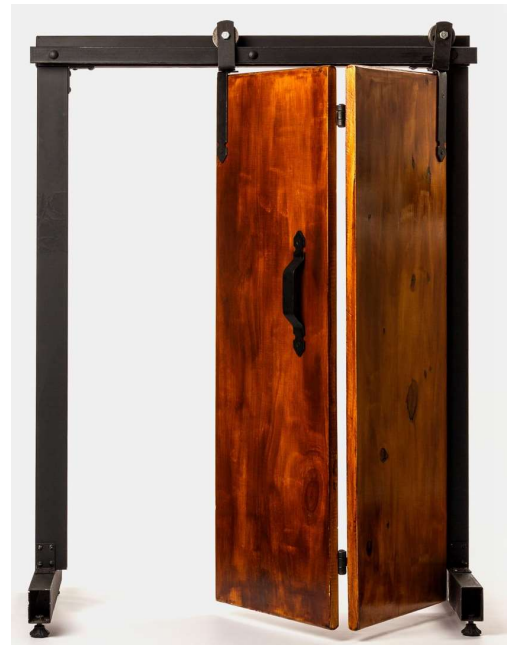

**CONFIANZA, CALIDAD Y PRESTIGIO NOS AVALAN**

FABRICACIÓN Y COMERCIALIZACIÓN DE HERRAJES S.A.  
**FCH**



FABRICACIÓN Y COMERCIALIZACIÓN DE HERRAJES S.A.

**FCH**



## BONIFICACIONES (consultar)

●  
 Importe antes de incluir el I.V.A.

### IMPORTANTE

● SI EFECTÚA TRANSFERENCIAS A NUESTRA CUENTA, NO OLVIDE ENVIAR FOTOCOPIA DE LA BOLETA DE DEPÓSITO.

Bco BBVA Cta Cte pesos N° 38296/7 Suc. 151  
 C.B.U. 017015134000003829673  
 ALIAS: FCH.HERRAJES

● RECUERDE QUE LOS RECLAMOS SE EFECTÚAN DENTRO DE LAS 48 HS. DE RECIBIDA LA MERCADERÍA.

● **LOS PEDIDOS SERAN FACTURADOS CON LA LISTA VIGENTE AL MOMENTO DE LA ENTREGA**



Panama 5945 (1682) M. Coronado-Pci. Bs. As.  
Tel. y Fax 4751-1533 / 9034 - info@fchsa.com.ar

**LISTA DE PRECIOS N° 94**

VIGENCIA DESDE EL 02 DE FEBRERO DE 2026

**HERRAJES FORJADOS**

BISAGRAS

**BISAGRAS DE AMURAR**

| ART       | MEDIDA | PLANCHUELA | PERNO   | P. UNI.     | X CAJA |
|-----------|--------|------------|---------|-------------|--------|
| 1525-10   | 10 cm. | 32x3 mm.   | Ø 9 1/2 | \$ 2.537,45 | 24     |
| 1525-13   | 13 cm. | 32x3 mm.   | Ø 9 1/2 | \$ 2.752,80 | 24     |
| 1525-20   | 20 cm. | 32x3 mm.   | Ø 9 1/2 | \$ 3.207,35 | 18     |
| 1525-25   | 25 cm. | 32x3 mm.   | Ø 9 1/2 | \$ 3.534,30 | 18     |
| 1525-18-R | 18 cm. | 38x5 mm.   | Ø 12    | \$ 5.991,55 | 10     |
| 1525-30   | 30 cm. | 38x5 mm.   | Ø 12    | \$ 7.354,20 | 8      |

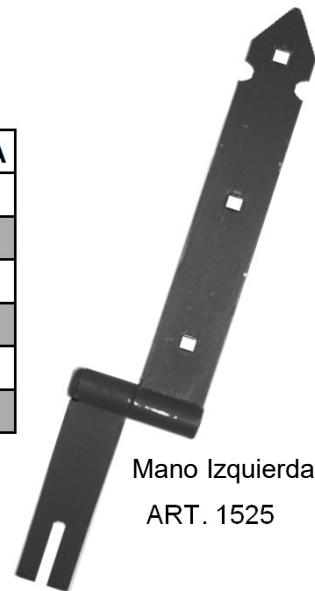

Mano Izquierda  
ART. 1525

**BISAGRAS DE ATORNILLAR**

| ART        | MEDIDA | PLANCHUELA | PERNO   | P. UNI.     | X CAJA |
|------------|--------|------------|---------|-------------|--------|
| 1527-10    | 10 cm. | 32x3       | Ø 9 1/2 | \$ 2.804,00 | 24     |
| 1527-10-AC | 10 cm. | 32x3       | Ø 9 1/2 | \$ 2.804,00 | 24     |
| 1527-13    | 13 cm. | 32x3       | Ø 9 1/2 | \$ 3.019,30 | 24     |
| 1527-13-AC | 13 cm. | 32x3       | Ø 9 1/2 | \$ 3.019,30 | 24     |
| 1527-20    | 20 cm. | 32x3       | Ø 12    | \$ 3.473,85 | 18     |
| 1527-20-AC | 20 cm. | 32x3       | Ø 12    | \$ 3.473,85 | 18     |
| 1527-25    | 25 cm. | 32x3       | Ø 12    | \$ 3.800,80 | 18     |
| 1527-18-R  | 18 cm. | 38x5       | Ø 12    | \$ 6.256,15 | 10     |
| 1527-30    | 30 cm. | 38x5       | Ø 12    | \$ 8.833,70 | 8      |



ART. 1527



ART. 1527-AC

## HERRAJES FORJADOS

### BISAGRAS CON BULON PARA POSTE

| ART       | MEDIDA | PLANCHUELA | PERNO   | P. UNI.      | X CAJA |
|-----------|--------|------------|---------|--------------|--------|
| 1528-10   | 10 cm. | 32X3 mm.   | Ø 9 1/2 | \$ 4.450,95  | 24     |
| 1528-13   | 13 cm. | 32X3 mm.   | Ø 9 1/2 | \$ 4.666,30  | 24     |
| 1528-20   | 20 cm. | 32X3 mm.   | Ø 9 1/2 | \$ 5.120,85  | 18     |
| 1528-25   | 25 cm. | 32X3 mm.   | Ø 9 1/2 | \$ 5.447,80  | 18     |
| 1528-18-R | 18 cm. | 38X5 mm.   | Ø 12    | \$ 8.917,45  | 10     |
| 1528-30   | 30 cm. | 38X5 mm.   | Ø 12    | \$ 10.384,90 | 8      |

TODAS LAS BISAGRAS CON PERNO DE 22 CM DE LARGO CON ROSCA DE 15 CM



ART. 1528  
Mano Derecha

### BISAGRAS DOBLE ALA

| ART       | MEDIDA | PLANCHUELA | PERNO   | P. UNI.     | X CAJA |
|-----------|--------|------------|---------|-------------|--------|
| 1529-10   | 10 cm. | 32X3 mm.   | Ø 9 1/2 | \$ 2.829,00 | 24     |
| 1529-13   | 13 cm. | 32X3 mm.   | Ø 9 1/2 | \$ 3.163,95 | 24     |
| 1529-20   | 20 cm. | 32X3 mm.   | Ø 9 1/2 | \$ 4.367,45 | 20     |
| 1529-18-R | 18 cm. | 38X5 mm.   | Ø 12    | \$ 8.168,00 | 16     |



ART. 1529

### ESCUADRAS PLANAS

| ART     | MEDIDA    | PLANCHUELA | P. UNI.     | X CAJA |
|---------|-----------|------------|-------------|--------|
| 1623-13 | 13x13 cm. | 32X3 mm.   | \$ 3.325,50 | 12     |
| 1623-20 | 20x20 cm. | 32X3 mm.   | \$ 4.445,85 | 12     |
| 1623-25 | 25x25 cm. | 32X3 mm.   | \$ 5.064,20 | 12     |

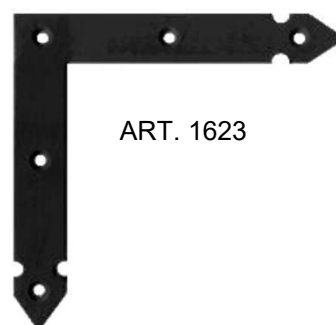

ART. 1623

### BISAGRAS DOBLE ALA CARROCERA

| ART        | MEDIDA | PLANCHUELA | PERNO   | P. UNI.     | X CAJA |
|------------|--------|------------|---------|-------------|--------|
| 1564-10-SA | 10 cm. | 63x3 mm.   | Ø 9 1/2 | \$ 4.048,50 | 16     |
| 1564-13-SA | 13 cm. | 75x5 mm.   | Ø 12    | \$ 7.521,35 | 8      |
| 1564-10    | 10 cm. | 63x3 mm.   | Ø 9 1/2 | \$ 4.109,70 | 16     |
| 1564-13    | 13 cm. | 75x5 mm.   | Ø 12    | \$ 8.164,50 | 8      |



ART. 1564

## HERRAJES FORJADOS

### HERRAJES PARA BAUL

| ART     | MEDIDA | PLANCH.  | DESCRIP.    | TERM. | P. UNI.     | X CAJA |
|---------|--------|----------|-------------|-------|-------------|--------|
| 1544    | 11 cm. | 38x3 mm. | Porta Cand. | Pint. | \$ 3.450,50 | 8      |
| 1555    | 4 cm.  | 38x3 mm. | B. Baul     | Pint. | \$ 2.517,50 | 24     |
| 1556    | 18 cm. | 38x5 mm. | M. Baul     | Pint. | \$ 5.185,65 | 12     |
| 1557-10 | 10 cm. | 12x3 mm. | M. Puente   | Pint. | \$ 838,05   | 50     |
| 1557-15 | 15 cm. | 25x3 mm. | M. Puente   | Pint. | \$ 941,30   | 50     |
| 1557-20 | 20 cm. | 32x3 mm. | M. Puente   | Pint. | \$ 1.913,30 | 24     |

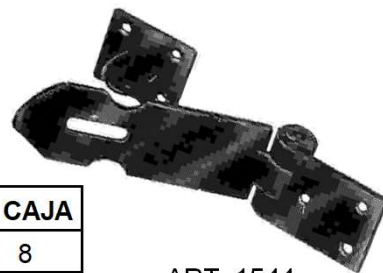

ART. 1544

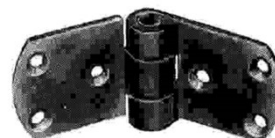

ART. 1555

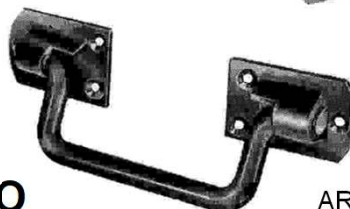

ART. 1556

### HERRAJES PARA POSTIGO

| ART      | MEDIDA | PLANCH.  | DESCRIP. | TERM. | P. UNI.     | X CAJA |
|----------|--------|----------|----------|-------|-------------|--------|
| 1530-T   | 10 cm. | 19x5 mm. | Reten    | Pint. | \$ 2.652,60 | 24     |
| 1530-T-Z | 10 cm. | 19x5 mm. | Reten    | Zinc. | \$ 3.665,95 | 24     |

### HERRAJES PARA PASAMANO

| ART       | PERNO   | BASE        | PERNO | TERM. | P. UNI.     | X CAJA |
|-----------|---------|-------------|-------|-------|-------------|--------|
| 1532-AT   | 6+4 cm. | 38x3X60 mm. | Ø 11  | Pint. | \$ 4.674,45 | 18     |
| 1532-AT-Z | 6+4 cm. | 38x3X60 mm. | Ø 11  | ZINC. | \$ 6.042,20 | 18     |
| 1532-T    | 6+4 cm. | 38x3X60 mm. | Ø 11  | Pint. | \$ 4.313,25 | 18     |
| 1532-T-Z  | 6+4 cm. | 38x3X60 mm. | Ø 11  | ZINC. | \$ 5.454,15 | 18     |
| 1533-AT   | 6+4 cm. | 38x3X60 mm. | Ø 11  | Pint. | \$ 4.674,45 | 18     |
| 1533-AT-Z | 6+4 cm. | 38x3X60 mm. | Ø 11  | ZINC. | \$ 6.042,20 | 18     |
| 1533-T    | 6+4 cm. | 38x3X60 mm. | Ø 11  | Pint. | \$ 4.313,25 | 18     |
| 1533-T-Z  | 6+4 cm. | 38x3X60 mm. | Ø 11  | ZINC. | \$ 5.454,15 | 18     |



ART. 1557

ART. 1557-20

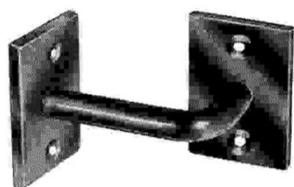

ART. 1532-AT



ART. 1532-T



ART. 1530-T

## HERRAJES FORJADOS

Panama 5945 (1682) M. Coronado-Pci. Bs. As.  
Tel. y Fax 4751-1533 / 9034 - info@fchsa.com.ar

### ACCESORIOS PARA MARCO

| ART    | MEDIDA | CHAPA   | DESCRIP. | P. UNI.   | X CAJA |
|--------|--------|---------|----------|-----------|--------|
| 1534-L | 15 cm. | 0,9 mm. | G. Ond.  | \$ 484,55 | 50     |
| 1534-R | 15 cm. | 0,9 mm. | G. Ond.  | \$ 582,10 | 50     |

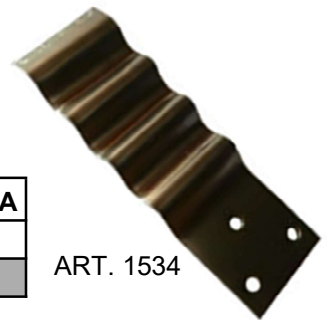

ART. 1534

### MENSULAS DE ESTILO

| ART       | MEDIDA    | PLANCH.  | RIZO     | P. UNI.      | X CAJA |
|-----------|-----------|----------|----------|--------------|--------|
| 1620-15   | 15x12 cm. | 19x5 mm. | 12x3 mm. | \$ 3.707,65  | 12     |
| 1620-20   | 20x15 cm. | 19x5 mm. | 12x3 mm. | \$ 4.294,05  | 12     |
| 1620-25   | 25x20 cm. | 19x5 mm. | 12x3 mm. | \$ 5.109,80  | 12     |
| 1620-30   | 30x25 cm. | 19x5 mm. | 12x3 mm. | \$ 6.676,35  | 12     |
| 1620-40   | 40x30 cm. | 25x5 mm. | 19x5 mm. | \$ 10.229,10 | 6      |
| 1620-50   | 50x40 cm. | 25x5 mm. | 19x5 mm. | \$ 12.453,30 | 6      |
| 1620-70-A | 70x50 cm. | 32x3 mm. | 19x5 mm. | \$ 13.944,15 | 6      |



ART. 1620

### MENSULAS CON REFUERZO RECTO

| ART         | MEDIDA    | PLANCH.  | RZO.     | P. UNI.      | X CAJA |
|-------------|-----------|----------|----------|--------------|--------|
| 1620-R-15   | 15x12 cm. | 19x5 mm. | 12x3 mm. | \$ 3.183,15  | 12     |
| 1620-R-20   | 20x15 cm. | 19x5 mm. | 12x3 mm. | \$ 3.714,35  | 12     |
| 1620-R-25   | 25x20 cm. | 19x5 mm. | 12x3 mm. | \$ 4.511,70  | 12     |
| 1620-R-25-M | 25x25 cm. | 32x3 mm. | 32x3 mm. | \$ 6.720,40  | 6      |
| 1620-R-30   | 30x25 cm. | 19x5 mm. | 12x3 mm. | \$ 5.755,45  | 12     |
| 1620-R-40   | 40x30 cm. | 25x5 mm. | 19x5 mm. | \$ 9.350,50  | 6      |
| 1620-R-50   | 50x40 cm. | 25x5 mm. | 19x5 mm. | \$ 11.667,15 | 6      |

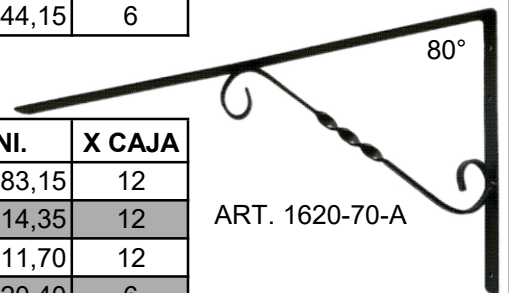

80°

ART. 1620-70-A

### MENSULA INVISIBLE

| ART         | MEDIDA | PERNO | Term. | P. UNI.     | X CAJA |
|-------------|--------|-------|-------|-------------|--------|
| 1620-I-20-Z | 20 cm. | ∅ 11  | Zinc. | \$ 5.274,95 | 12     |

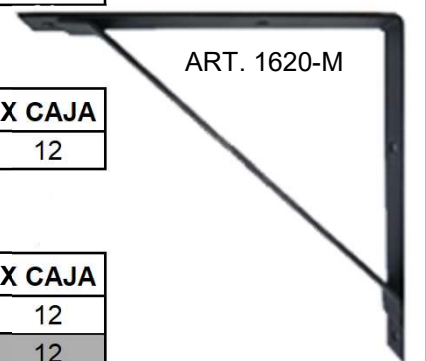

ART. 1620-M

### ESCUADRAS

| ART      | MEDIDA      | PLANCH.  | Term.   | P. UNI.     | X CAJA |
|----------|-------------|----------|---------|-------------|--------|
| 1621-2-Z | 2,5x2,5 cm. | 12x3 mm. | Zincado | \$ 594,70   | 12     |
| 1621-5-Z | 5x5 cm.     | 12x3 mm. | Zincado | \$ 806,45   | 12     |
| 1621-7-Z | 7,5x7,5 cm. | 12x3 mm. | Zincado | \$ 1.083,35 | 12     |
| 1621-10  | 10x10 cm.   | 19x5 mm. | Pintado | \$ 1.958,85 | 12     |
| 1621-15  | 15x12 cm.   | 19x5 mm. | Pintado | \$ 2.438,50 | 12     |
| 1621-20  | 20x15 cm.   | 19x5 mm. | Pintado | \$ 2.902,40 | 12     |



ART. 1621



ART. 1620-I

## HERRAJES FORJADOS

Panama 5945 (1682) M. Coronado-Pci. Bs. As.  
Tel. y Fax 4751-1533 / 9034 - info@fchsa.com.ar

### PASADORES CON PUENTE SOLDADO

| ART       | MEDIDA | BASE         | PASADOR | TERM.   | P. UNI.     | X CAJA |
|-----------|--------|--------------|---------|---------|-------------|--------|
| 1543-10   | 10 cm. | 32x3x60 mm.  | 12X6    | Pintado | \$ 3.076,70 | 24     |
| 1543-10-P | 10 cm. | 32x3x60 mm.  | 12X6    | Pintado | \$ 3.076,75 | 24     |
| 1543-15   | 15 cm. | 32x3x90 mm.  | 12X6    | Pintado | \$ 3.449,50 | 24     |
| 1543-15-P | 15 cm. | 32x3x90 mm.  | 12X6    | Pintado | \$ 3.792,40 | 24     |
| 1543-20   | 20 cm. | 32x3x140 mm. | 12X6    | Pintado | \$ 4.856,95 | 18     |
| 1543-20-P | 20 cm. | 32x3x140 mm. | 12X6    | Pintado | \$ 5.226,25 | 18     |

ART. 1543-P



ART. 1543



### PASADORES CON BASE EN "U"

| ART       | MEDIDA | BASE         | PASADOR | TERM.   | P. UNI.     | X CAJA |
|-----------|--------|--------------|---------|---------|-------------|--------|
| 1565-10   | 7 cm.  | 32x3x40 mm.  | 12X6    | Pintado | \$ 2.297,60 | 24     |
| 1565-10-P | 7 cm.  | 32x3x40 mm.  | 12X6    | Pintado | \$ 2.632,50 | 24     |
| 1565-15   | 10 cm. | 32x3x50 mm.  | 12X6    | Pintado | \$ 2.483,65 | 24     |
| 1565-15-P | 10 cm. | 32x3x50 mm.  | 12X6    | Pintado | \$ 2.874,40 | 24     |
| 1565-20   | 20 cm. | 32x3x105 mm. | 12X6    | Pintado | \$ 3.458,05 | 18     |
| 1565-20-P | 20 cm. | 32x3x105 mm. | 12X6    | Pintado | \$ 3.761,05 | 18     |



ART. 1565

**HERRAJES FORJADOS**

Panama 5945 (1682) M. Coronado-Pci. Bs. As.  
 Tel. y Fax 4751-1533 / 9034 - info@fchsa.com.ar

**PASADORES AL PISO (S/PTE. DE ATORNILLAR)**

| ART     | MEDIDA | BASE         | PASADOR | TERM.   | P. UNI.      | X CAJA |
|---------|--------|--------------|---------|---------|--------------|--------|
| 1535-25 | 25 cm. | 32x3x100 mm. | Ø 9 1/2 | Pintado | \$ 3.562,45  | 18     |
| 1535-30 | 30 cm. | 38x3x120 mm. | Ø 12    | Pintado | \$ 4.839,50  | 12     |
| 1541-15 | 15 cm. | 32x3x90 mm.  | Ø 9 1/2 | Pintado | \$ 3.206,35  | 24     |
| 1541-30 | 30 cm. | 38x3x150 mm. | Ø 11    | Pintado | \$ 5.130,25  | 20     |
| 1541-40 | 40 cm. | 50x3x200 mm. | Ø 16    | Pintado | \$ 10.924,05 | 6      |
| 1541-50 | 50 cm. | 50x3x270 mm. | Ø 16    | Pintado | \$ 13.807,95 | 6      |

☆ Pasador de Piso con porta candado + 10 % ☆



ART. 1541

**PUENTES PARA ATORNILLAR AL MARCO**

| ART         | PLANCH.  | PUENTE PARA        | TERM.   | P. UNI.     | X CAJA |
|-------------|----------|--------------------|---------|-------------|--------|
| 1535-25-PUE | 32x3 mm. | 1535-25            | Pintado | \$ 949,80   | 12     |
| 1535-30-PUE | 38x3 mm. | 1535-30            | Pintado | \$ 992,75   | 12     |
| 1541-15-PUE | 32x3 mm. | 1541-15            | Pintado | \$ 1.154,35 | 12     |
| 1541-30-PUE | 38x3 mm. | 1541-30            | Pintado | \$ 1.285,80 | 12     |
| 1541-40-PUE | 50x5 mm. | 1541-40/50         | Pintado | \$ 1.925,95 | 12     |
| 1540-PORT   | 32x5 mm. | PUENTE PORTA CAND. | Pintado | \$ 1.015,35 | 12     |



ART. 1541-PUE



ART. 1540-PORT



ART. 1535-PUE

**CERROJOS**

| ART     | MEDIDA | PLANCH.      | PASADOR | TERM.   | P. UNI.      | X CAJA |
|---------|--------|--------------|---------|---------|--------------|--------|
| 1540-15 | 15 cm. | 32x3x90 mm.  | Ø 9 1/2 | Pintado | \$ 4.745,35  | 18     |
| 1540-20 | 20 cm. | 38x3x150 mm. | Ø 11    | Pintado | \$ 6.545,25  | 10     |
| 1540-30 | 30 cm. | 50x3x200 mm. | Ø 16    | Pintado | \$ 14.552,50 | 4      |
| 1540-40 | 40 cm. | 50x3x270 mm. | Ø 16    | Pintado | \$ 15.988,85 | 4      |

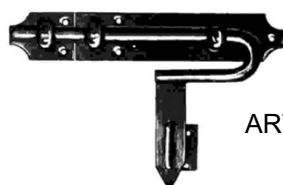

ART. 1540

**HERRAJES FORJADOS**

Panama 5945 (1682) M. Coronado-Pci. Bs. As.  
 Tel. y Fax 4751-1533 / 9034 - info@fchsa.com.ar

**GANCHO CONTRAVIENTO**



ART. 1622

| ART       | MEDIDA | BASE        | PERNO | TERM.   | P. UNI.     | X CAJA |
|-----------|--------|-------------|-------|---------|-------------|--------|
| 1622-10   | 10 cm. | 32X3x50 mm. | Ø 8   | Pintado | \$ 3.475,76 | 12     |
| 1622-10-Z | 10 cm. | 32X3x50 mm. | Ø 8   | Zincado | \$ 4.872,45 | 12     |
| 1622-15   | 15 cm. | 32X3x50 mm. | Ø 8   | Pintado | \$ 3.639,14 | 10     |
| 1622-15-Z | 15 cm. | 32X3x50 mm. | Ø 8   | Zincado | \$ 5.194,30 | 10     |

**ALDABAS DE HIERRO FORJADO**



ART. 1624

| ART     | MEDIDA | PLANCH.  | P. UNI.     | X CAJA |
|---------|--------|----------|-------------|--------|
| 1624-6  | 6 cm.  | 12X3 mm. | \$ 1.423,60 | 24     |
| 1624-12 | 12 cm. | 25X3 mm. | \$ 2.538,65 | 18     |

**MANIJONES**

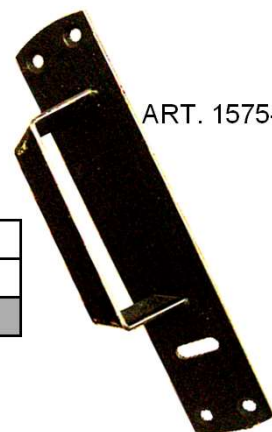

ART. 1575-L

| ART      | ALTA   | BASE     | MANO  | TERM.   | P. UNI.      | X CAJA |
|----------|--------|----------|-------|---------|--------------|--------|
| 1575-L   | 25 cm. | 50X3 mm. | I Y D | Pintado | \$ 7.789,75  | 8      |
| 1575-L-Z | 25 cm. | 50X3 mm. | I Y D | Zincado | \$ 10.957,45 | 8      |

**PORTA TRANCA**

| ART      | MEDIDA  | PLANCH.  | DESCRIPCOPN       | TERM.   | P. UNI.      | X CAJA |
|----------|---------|----------|-------------------|---------|--------------|--------|
| 1580-32  |         | 32x5 mm. | P/TRANCA DE 50X32 | Pintado | \$ 2.180,35  | 24     |
| 1580-25  |         | 32x5 mm. | P/TRANCA DE 50X25 | Pintado | \$ 2.180,35  | 24     |
| 1580-7   |         | 32x5 mm. | P/TRANCA DE 50X7  | Pintado | \$ 2.180,35  | 24     |
| 1580-TRA | 100 cm. | 50X5 mm. | TRANCA DE 1 MT.   | Pintado | \$ 16.242,85 | 6      |
| 1581     |         | 32X3 mm. | CON PERNO Y CAND. | Pintado | \$ 6.435,75  | 12     |

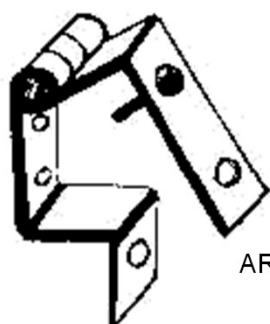

ART. 1581



ART. 1580

## ACCESORIOS RURALES

Panama 5945 (1682) M. Coronado-Pci. Bs. As.  
Tel. y Fax 4751-1533 / 9034 - info@fchsa.com.ar

### BISAGRAS PARA TRANQUERA



ART. 1700

| ART     | MEDIDA | PLANCH.  | PERNO | ABERT. | P. UNI.      | X CAJA |
|---------|--------|----------|-------|--------|--------------|--------|
| 1700-18 | 18 cm. | 50x3 mm. | 14    | 1 3/4" | \$ 13.070,70 | 12     |
| 1700-20 | 20 cm. | 50x5 mm. | 16    | 2 1/2" | \$ 16.020,65 | 12     |
| 1700-25 | 25 cm. | 50x5 mm. | 16    | 3"     | \$ 17.481,15 | 10     |
| 1700-30 | 30 cm. | 50x5 mm. | 19    | 3"     | \$ 22.397,35 | 8      |
| 1700-40 | 40 cm. | 63x6 mm. | 22    | 3"     | \$ 46.065,15 | 4      |



ART. 1710-29

### AROS

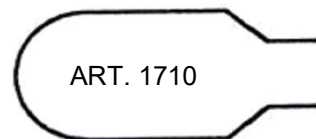

ART. 1710

| ART     | MEDIDA | PLANCH.  | ABERT. | NRO.  | P. UNI.     | X CAJA |
|---------|--------|----------|--------|-------|-------------|--------|
| 1710-27 | 27 cm. | 25x5 mm. | 2"     | 1     | \$ 6.297,90 | 6      |
| 1710-29 | 29 cm. | 38x5 mm. | 3"     | DOBLE | \$ 8.900,90 | 6      |
| 1710-30 | 30 cm. | 25x5mm.  | 2"     | 2     | \$ 6.900,20 | 6      |



ART. 1720

### PASADOR DE PUERTA PARA MANGA

| ART     | MEDIDA | PLANCH.  | PERNO | P. UNI.      | X CAJA |
|---------|--------|----------|-------|--------------|--------|
| 1720-11 | 11 cm. | 50X5 mm. | Ø11   | \$ 6.139,70  | 6      |
| 1720-17 | 17 cm. | 50X5 mm. | Ø 16  | \$ 9.403,45  | 6      |
| 1720-19 | 19 cm. | 50X5 mm. | Ø 19  | \$ 11.333,05 | 6      |

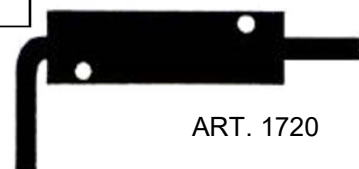

ART. 1730

### TORNIQUETES

| ART      | MEDIDA | PLANCH. | PERNO | TERM.   | P. UNI.      | X CAJA |
|----------|--------|---------|-------|---------|--------------|--------|
| 1730-3   | Mini   | 25X3    | Ø 12  | Pintado | \$ 2.891,00  | 24     |
| 1730-3-Z | Mini   | 25X3    | Ø 12  | Zincado | \$ 4.308,35  | 24     |
| 1730-6   | N*6    | 32X5    | Ø 14  | Pintado | \$ 4.734,35  | 24     |
| 1730-6-Z | N*6    | 32X5    | Ø 14  | Zincado | \$ 7.852,45  | 24     |
| 1730-7   | N*7    | 32X3    | Ø 14  | Pintado | \$ 4.261,85  | 24     |
| 1730-7-Z | N*7    | 32X3    | Ø 14  | Zincado | \$ 6.834,25  | 24     |
| 1730-8   | N*8    | 38X5    | Ø 16  | Pintado | \$ 5.908,10  | 24     |
| 1730-8-Z | N*8    | 38X5    | Ø 16  | Zincado | \$ 10.124,65 | 24     |



ART. 1705-T

ART. 1705-R

### BISAGRAS

| ART    | MEDIDA | PLANCH. | PERNO | TIPO     | P. UNI.      | X CAJA |
|--------|--------|---------|-------|----------|--------------|--------|
| 1705-D | 19 cm. | 38x5    | Ø 12  | VOLCABLE | \$ 8.086,95  | 8      |
| 1705-R | 19 cm. | 38x5    | Ø 12  | D. RECTA | \$ 7.123,90  | 10     |
| 1705-T | 25 cm. | 50x5    | Ø 12  | B. "T"   | \$ 11.833,60 | 12     |



ART. 1705-D

## HERRAJES DE ESTILO

Panama 5945 (1682) M. Coronado-Pci. Bs. As.  
 Tel. y Fax 4751-1533 / 9034 - info@fchsa.com.ar

### MANIJONES Y MANIJAS

| ART  | DESCRIPCION                       | P. UNI.      | X CAJA |
|------|-----------------------------------|--------------|--------|
| 1560 | MEDIA MANIJA DE EST. CRUZ         | \$ 8.307,10  | 6      |
| 1561 | MANIJA BALANCIN DE EST. GIRATORIA | \$ 8.542,20  | 6      |
| 1562 | BOCALLAVE DE ESTILO               | \$ 1.055,35  | 12     |
| 1563 | MANIJA DOBLE BALANCIN             | \$ 12.802,90 | 6      |
| 1566 | TIRADOR DE ESTILO                 | \$ 3.396,95  | 12     |

ART. 1562

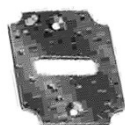

ART. 1566

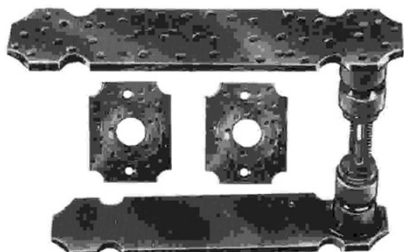

ART. 1563



ART. 1560

**HERRAJES P/HERRERO**

Panama 5945 (1682) M. Coronado-Pci. Bs. As.  
 Tel. y Fax 4751-1533 / 9034 - info@fchsa.com.ar

**BISAGRAS DE HERRERO PARA AMURAR**

| ART      | ALA 1   | PATA | PERNO   | P. UNI.     | X CAJA |
|----------|---------|------|---------|-------------|--------|
| 1524-L1  | 32x3x15 | 25x3 | Ø 9 1/2 | \$ 2.154,95 | 24     |
| 1524-L4  | 32x3x40 | 25x3 | Ø 9 1/2 | \$ 2.340,00 | 24     |
| 1524-R1  | 32x5x15 | 32x5 | Ø 12    | \$ 3.732,95 | 24     |
| 1524-R12 | 32x5x40 | 32x5 | Ø 12    | \$ 3.918,05 | 24     |
| 1524-R2  | 38x5x15 | 32x5 | Ø 12    | \$ 3.964,90 | 24     |
| 1524-R22 | 38x5x40 | 32x5 | Ø 12    | \$ 4.166,05 | 24     |
| 1524-R5  | 50x5x15 | 38x5 | Ø 12    | \$ 4.909,70 | 24     |
| 1524-R6  | 50x5x40 | 38x5 | Ø 12    | \$ 5.209,70 | 24     |

PATA



ALA 1

ART. 1524

**BISAGRAS DOBLE ALA HERRERO P/SOLDAR**

| ART      | ALAS    | PERNO   | P. UNI.     | X CAJA |
|----------|---------|---------|-------------|--------|
| 1523-L   | 32x3x15 | Ø 9 1/2 | \$ 1.725,10 | 24     |
| 1523-L2  | 32x3x40 | Ø 9 1/2 | \$ 2.060,05 | 24     |
| 1523-R1  | 32x5x15 | Ø 12    | \$ 2.579,20 | 24     |
| 1523-R12 | 32x5x40 | Ø 12    | \$ 2.922,95 | 24     |
| 1523-R2  | 38x5x15 | Ø 12    | \$ 2.935,75 | 24     |
| 1523-R22 | 38x5x40 | Ø 12    | \$ 3.309,40 | 24     |
| 1523-R3  | 50x5x15 | Ø 12    | \$ 3.854,60 | 24     |
| 1523-R4  | 50x5x40 | Ø 12    | \$ 4.454,60 | 24     |



ART. 1523

**CAJAS PARA CERRADURA**

| ART     | MEDIDA | DESCRIPCION  | P. UNI.     | X CAJA |
|---------|--------|--------------|-------------|--------|
| 1800-25 | 1"     | DE 17X7,5 CM | \$ 3.668,25 | 8      |
| 1800-32 | 1 1/4" | DE 17X7,5 CM | \$ 4.392,75 | 8      |



ART. 1800

**CAJAS PARA CERROJO**

| ART     | MEDIDA | DESCRIPCION  | P. UNI.     | X CAJA |
|---------|--------|--------------|-------------|--------|
| 1810-25 | 1"     | DE 10X7,5 CM | \$ 2.714,75 | 14     |
| 1810-32 | 1 1/4" | DE 10X7,5 CM | \$ 3.148,25 | 14     |



ART. 1810

**ACC. P/ CORTINAS DE ENROLLAR  
 Y REGULABLES**

**ENROLLADORES**

| ART       | DESCRIPCION                          | P. UNI.      | X CAJA |
|-----------|--------------------------------------|--------------|--------|
| 2000-4-G  | E. de 4 mts. Galvanizado             | \$ 6.996,78  | 18     |
| 2000-4-ZB | E. de 4 mts. pintado epoxi con buche | \$ 31.054,65 | 6      |
| 2000-6-G  | E. de 6 mts. Galvanizado             | \$ 9.541,21  | 12     |
| 2000-6-ZB | E. de 6 mts. pintado epoxi con buche | \$ 36.458,30 | 6      |
| 2000-8-Z  | E. de 8 mts. pintado epoxi           | \$ 41.072,05 | 6      |
| 2000-8-ZB | E. de 8 mts. pintado epoxi con buche | \$ 49.284,80 | 6      |
| 2000-10-Z | E. de 10 mts. pintado epoxi          | \$ 63.748,55 | 6      |



ART. 2000



ART. 2000-8/10

**POLEAS**

| ART    | MEDIDA                                     | P. UNI.     | X CAJA |
|--------|--|-------------|--------|
| 2002-P | Corazón de plástico p/eje octog. de 70 mm. | \$ 1.165,21 | 10     |



ART. 2002

**ACC. P/ CORTINAS DE ENROLLAR Y EGULABLES**

**ACCESORIOS**

ART. 2010-E

| ART        | DESCRIPCION                                  | P. UNI.       | X CAJA |
|------------|--|---------------|--------|
| 2010-E     | Gpa. Giratoria. estampada de chapa           | \$ 612,96     | 12     |
| 2010-R     | Gpa. Giratoria. Ref. planch. de 25 x 5 mm.   | \$ 1.350,77   | 12     |
| 2011       | Gpa. para rulemán planch. de 25 x 6 mm.      | \$ 1.264,94   | 12     |
| 2012       | Ruleman                                      | \$ 8.888,45   | 12     |
| 2013-L     | Punta de eje liviana                         | \$ 313,53     | 12     |
| 2013-R     | Punta de eje reforzada                       | \$ 658,77     | 12     |
| 2014-G     | Pasacinta sple. c/rodillo de madera. Galv.   | \$ 653,31     | 12     |
| 2015-G     | Pasacinta doble c/rodillo de madera. Galv.   | \$ 918,24     | 12     |
| 2017-4     | Caja de 4 mts. de madera                     | \$ 2.191,00   | 20     |
| 2017-6     | Caja de 6 mts. de madera                     | \$ 2.736,80   | 20     |
| 2017-8     | Caja de 8 mts. de madera                     | \$ 3.962,05   | 10     |
| 2018-60-P  | Taco de plástico para eje de 60 mm.          | \$ 859,00     | 12     |
| 2018-70-P  | Taco de plástico para eje de 70 mm.          | \$ 1.256,65   | 12     |
| 2019-G     | Tope de hierro Galvanizado                   | \$ 706,90     | 50     |
| 2019-P     | Tope de plastico blanco                      | \$ 85,25      | 50     |
| 2020-3     | Reductor de 1 x 3 de chapa c/Reduccion en H° | \$ 134.679,00 | 1      |
| 2020-3-P   | Reductor de 1 x 3 de chapa c/Reduccion en Ny | \$ 82.527,40  | 1      |
| 2020-4     | Reductor de 1 x 4 de chapa c/Reduccion en H° | \$ 177.760,75 | 1      |
| 2021       | Grampa para Reductor                         | \$ 8.473,65   | 1      |
| 2040-70-C  | Capuc. p/eje de 70 mm. Pint. Epoxi           | \$ 13.457,30  | 1      |
| 2040-P20-C | P. N°20 c/capuc. p/eje de 70 mm. Pint. Epoxi | \$ 26.046,30  | 1      |
| 2040-P23-C | P. N°23 c/capuc. p/eje de 70 mm. Pint. Epoxi | \$ 33.454,55  | 1      |
| 2040-P23-C | P. N°23 c/capuc. p/eje de 70 mm. Pint. Epoxi | \$ 33.454,55  | 1      |



ART. 2010



ART. 2011



ART. 2012



ART. 2013



ART. 2020



ART. 2014-G



ART. 2015-G



ART. 2019-G



ART. 2040-70-C



ART. 2018



ART. 2019-P



Panama 5945 (1682) M. Coronado-Pci. Bs. As.  
Tel. y Fax 4751-1533 / 9034 - info@fchsa.com.ar

**LISTA DE PRECIOS N° 94**

VIGENCIA DESDE EL 02 DE FEBRERO DE 2026

**ACC. P/ CORTINAS DE ENROLLAR Y EGULABLES**

ACC. P/CORTINAS

**HERRAJES PARA CORTINAS REGULABLES**

ART. 2023



| ART     | DESCRIPCION                 | P. UNI.      | X CAJA |
|---------|-----------------------------|--------------|--------|
| 2022    | Costanero                   | \$ 509,05    | 50     |
| 2023    | Fleje (el metro)            | \$ 16.128,15 | 25     |
| 2024    | Hebilla c/chicote           | \$ 1.908,85  | 24     |
| 2026    | Tubito                      | \$ 610,00    | 50     |
| 2027    | Bisagra                     | \$ 1.908,85  | 24     |
| 2028-40 | Rodillo de 40 mm. de madera | \$ 7.110,80  | 6      |
| 2028-60 | Rodillo de 60 mm. de madera | \$ 11.140,20 | 6      |

ART. 2027



ART. 2028-40



ART. 2028-60

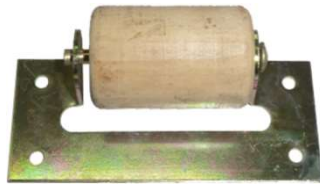

ART. 2024



**CINTAS**

| ART    | DESCRIPCIÓN                               | P. UNI.   | X CAJA |
|--------|---|-----------|--------|
| 2005-1 | Cta p/cortina N°1 x mt. %60 Alg./ %40 Ny. | \$ 442,80 | 50     |
| 2005-3 | Cta p/cortina N°3 x mt. %100 Alg.         | \$ 813,35 | 50     |

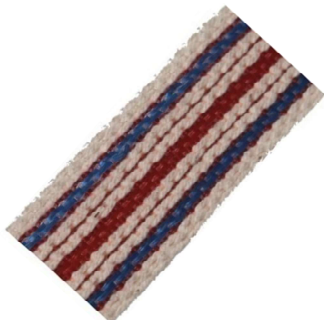

ART. 2005

## BULONES Y TIRAFONDOS

Panama 5945 (1682) M. Coronado-Pci. Bs. As.  
 Tel. y Fax 4751-1533 / 9034 - info@fchsa.com.ar

### BULONES EMPAVONADOS

Con tuerca y arandela  
 Precios por 100 un.

| mm.              |       | 6,35      | 7,95       | 9,53       |
|------------------|-------|-----------|------------|------------|
|                  | pulg. | 1/4       | 5/16       | 3/8        |
| 25               | 1"    | 32084,129 |            |            |
| 32               | 1 1/4 | 33198,699 | 60844,119  |            |
| 38               | 1 1/2 | 35408,193 | 64924,086  |            |
| 44               | 1 3/4 | 37774,014 | 67800,833  |            |
| 50               | 2"    | 44135,702 | 72446,567  | 101745,127 |
| 56               | 2 1/4 | 42420,411 | 76780,973  |            |
| 63               | 2 1/2 | 45264,675 | 34877,914  | 112144,325 |
| 69               | 2 3/4 | 47198,095 | 84346,091  |            |
| 75               | 3"    | 50420,642 | 86826,265  | 124540,582 |
| 81               | 3 1/4 | 53180,324 | 91413,783  |            |
| 90               | 3 1/2 | 54744,230 | 96010,100  | 135875,032 |
| 100              | 4"    | 59186,268 | 102639,967 | 145738,294 |
| 113              | 4 1/2 |           | 122028,133 | 180265,466 |
| 125              | 5"    |           | 135246,586 | 187901,607 |
| 140              | 5 1/2 |           | 148940,769 | 210411,497 |
| 153              | 6"    |           | 160631,204 | 236127,031 |
| 178              | 7"    |           | 174054,708 | 248384,528 |
| 200              | 8"    |           |            |            |
| Aran. Emp. x kg. |       | 27768,163 | 21071,637  | 24761,373  |
| Tca. Emp. x 100  |       | 9572,454  | 21071,637  | 24761,373  |

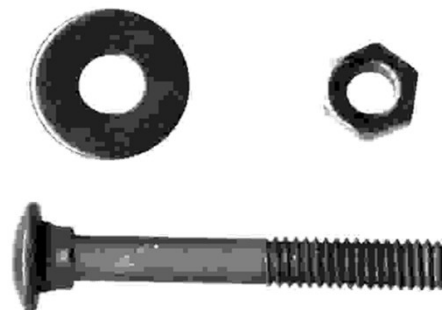

### TIRAFONDOS ZINCADOS

Precios por 100 un.

| mm.              |       | 4,76          | 6,35          | 7,95          |
|------------------|-------|---------------|---------------|---------------|
|                  | pulg. | 3/16          | 1/4           | 5/16          |
| 25               | 1"    | \$ 12.011,539 | \$ 9.733,649  | \$ 11.803,571 |
| 32               | 1 1/4 | \$ 14.533,518 | \$ 10.893,411 | \$ 18.028,632 |
| 38               | 1 1/2 | \$ 16.209,891 | \$ 11.939,293 | \$ 20.587,552 |
| 44               | 1 3/4 | \$ 17.243,408 | \$ 13.893,923 | \$ 22.179,613 |
| 50               | 2"    | \$ 18.850,551 | \$ 15.144,333 | \$ 22.532,888 |
| 56               | 2 1/4 | \$ 20.472,529 | \$ 16.838,654 | \$ 25.410,216 |
| 63               | 2 1/2 | \$ 22.786,815 | \$ 18.942,037 | \$ 27.415,978 |
| 69               | 2 3/4 | \$ 24.230,771 | \$ 19.715,987 | \$ 30.528,049 |
| 75               | 3"    | \$ 25.546,156 | \$ 21.784,502 | \$ 32.780,180 |
| 81               | 3 1/4 |               | \$ 24.343,422 | \$ 38.051,408 |
| 90               | 3 1/2 |               | \$ 26.435,180 | \$ 41.363,361 |
| 100              | 4"    |               | \$ 29.677,402 | \$ 46.032,630 |
| 113              | 4 1/2 |               | \$ 32.461,767 | \$ 50.690,281 |
| 125              | 5"    |               | \$ 35.587,783 | \$ 56.210,197 |
| Aran. Zinc x kg. |       | \$ 23.597,618 | \$ 27.768,163 | \$ 21.071,637 |
| Tca. Zinc. X 100 |       | \$ 3.528,616  | 9572,454      | 21071,637     |



## SOPORTE PARA TECHO

### ANGULOS PERFORADOS



Chapa Nº 13 (2,5 mm.)

| ART.   | MEDIDA |    |    | PRECIO x Unidad | CANTIDAD x PAQ. |
|--------|--------|----|----|-----------------|-----------------|
|        | A      | B  | C  |                 |                 |
| AP-240 | 240    | 33 | 33 | \$ 1.917,15     | 10              |
| AP-190 | 190    | 33 | 33 | \$ 1.734,55     | 10              |
| AP-140 | 140    | 33 | 33 | \$ 1.347,25     | 10              |
| AP-120 | 120    | 33 | 33 | \$ 1.120,40     | 10              |
| AP-90  | 90     | 33 | 33 | \$ 948,90       | 10              |
| AP-70  | 70     | 33 | 33 | \$ 752,50       | 10              |
| AP-45  | 45     | 33 | 33 | \$ 605,85       | 10              |

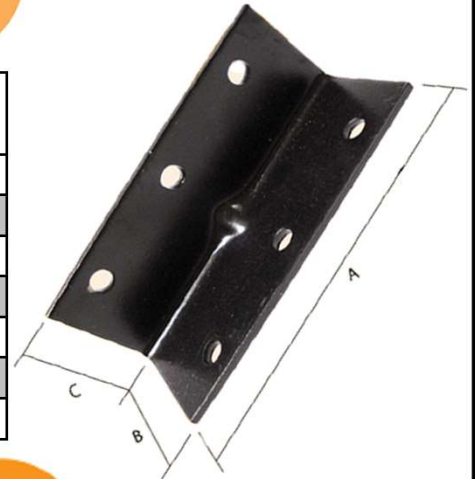

### PLACAS DE EMPATILLADO



Chapa Nº 13 (2,5 mm)

| ART.   | MEDIDA |     | PRECIO x Unidad | CANTIDAD x PAQ. |
|--------|--------|-----|-----------------|-----------------|
|        | A      | B   |                 |                 |
| PE-105 | 105    | 35  | \$ 580,95       | 10              |
| PE-135 | 135    | 45  | \$ 1.161,90     | 10              |
| PE-215 | 215    | 70  | \$ 2.354,25     | 10              |
| PE-145 | 145    | 70  | \$ 1.540,90     | 10              |
| PE-200 | 200    | 90  | \$ 4.133,05     | 10              |
| PE-240 | 240    | 115 | \$ 6.163,55     | 10              |
| PE-300 | 300    | 140 | \$ 9.748,80     | 10              |

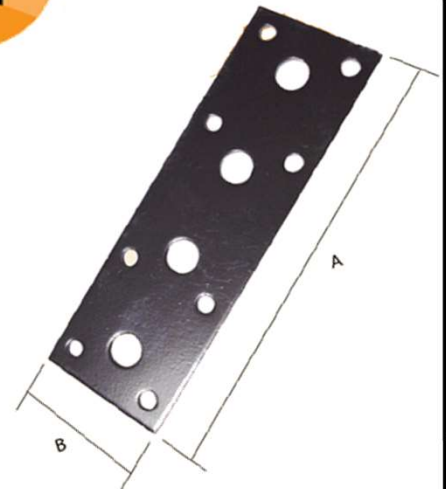

### SOPORTE EN "L"



Chapa Nº 13 (2,5 mm.)

| ART.      | MEDIDA |     |    | PRECIO x Unidad | CANTIDAD x PAQ. |
|-----------|--------|-----|----|-----------------|-----------------|
|           | A      | B   | C  |                 |                 |
| SL-45-70  | 70     | 70  | 45 | \$ 1.247,65     | 10              |
| SL-45-55  | 85     | 55  | 45 | \$ 1.247,65     | 10              |
| SL-35-50  | 50     | 50  | 35 | \$ 818,90       | 10              |
| SL-35-110 | 100    | 100 | 35 | \$ 1.493,90     | 10              |
| SL-70-110 | 100    | 100 | 70 | \$ 2.749,85     | 10              |
| SL-70-160 | 60     | 160 | 70 | \$ 2.749,85     | 10              |
| SL-70-70  | 70     | 70  | 70 | \$ 1.767,75     | 10              |

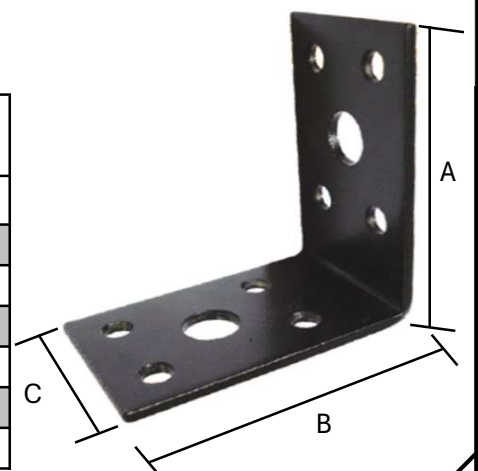

## SOPORTE PARA TECHO

### SOPORTES INDIVIDUALES 90°

Chapa N° 14 (2 mm)



| ART.    | MEDIDA |     |    | PRECIO x Unidad | CANTIDAD x PAQ. |
|---------|--------|-----|----|-----------------|-----------------|
|         | A      | B   | C  |                 |                 |
| SI-90-4 | 66     | 90  | 22 | \$ 4.088,75     | 12              |
| SI-90-5 | 66     | 115 | 22 | \$ 4.885,50     | 12              |
| SI-90-6 | 66     | 140 | 22 | \$ 5.452,60     | 12              |

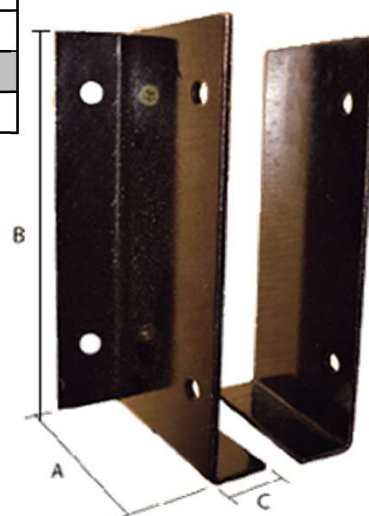

### CAJAS INDIVIDUALES 90°

Chapa N° 14 (2 mm)



| ART. | MEDIDA |     |    | PRECIO x Unidad | CANTIDAD x PAQ. |
|------|--------|-----|----|-----------------|-----------------|
|      | A      | B   | C  |                 |                 |
| CI-4 | 66     | 90  | 22 | \$ 4.088,75     | 12              |
| CI-5 | 66     | 115 | 22 | \$ 4.885,50     | 12              |
| CI-6 | 66     | 140 | 22 | \$ 5.452,60     | 12              |



## SOPORTE PARA TECHO

### SOPORTES CERRADOS 90°

Chapa N° 14 (2 mm)

| ART.   | MEDIDA |     |    | PRECIO x<br>Unidad | CANTIDA<br>D x PAQ. |
|--------|--------|-----|----|--------------------|---------------------|
|        | A      | B   | C  |                    |                     |
| SC-4   | 66     | 90  | 48 | \$ 3.557,60        | 12                  |
| SC-5   | 66     | 115 | 48 | \$ 4.481,60        | 12                  |
| SC-6   | 66     | 140 | 48 | \$ 4.979,55        | 12                  |
| SC-6X3 | 66     | 140 | 70 | \$ 5.839,90        | 12                  |
| SC-8X3 | 66     | 190 | 70 | \$ 7.848,30        | 12                  |

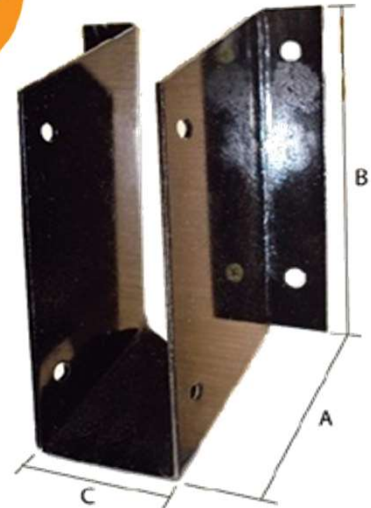

### CAJAS CERRADAS 90°

Chapa N° 14 (2 mm)

| ART.   | MEDIDA |     |    | PRECIO x<br>Unidad | CANTIDA<br>D x PAQ. |
|--------|--------|-----|----|--------------------|---------------------|
|        | A      | B   | C  |                    |                     |
| CC-4   | 66     | 90  | 48 | \$ 3.557,60        | 12                  |
| CC-5   | 66     | 115 | 48 | \$ 4.481,60        | 12                  |
| CC-6   | 66     | 140 | 48 | \$ 4.979,55        | 12                  |
| CC-6X3 | 66     | 140 | 70 | \$ 5.839,90        | 12                  |
| CC-8X3 | 66     | 190 | 70 | \$ 7.848,30        | 12                  |

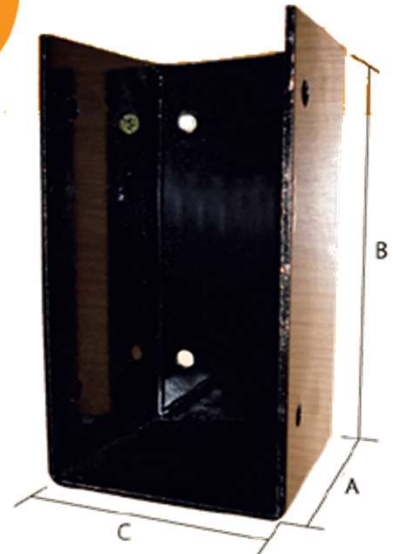

### CUMBRERAS

Chapa N° 14 (2 mm)

| ART.     | MEDIDA |     |     | PRECIO x<br>Unidad | CANTIDA<br>D x PAQ. |
|----------|--------|-----|-----|--------------------|---------------------|
|          | A      | B   | C   |                    |                     |
| C-30-150 | 145    | 150 | 30° | \$ 5.358,55        | 12                  |
| C-30-185 | 145    | 185 | 30° | \$ 6.075,05        | 12                  |
| C-45-150 | 145    | 150 | 45° | \$ 5.892,45        | 12                  |
| C-45-185 | 145    | 185 | 45° | \$ 7.176,05        | 12                  |

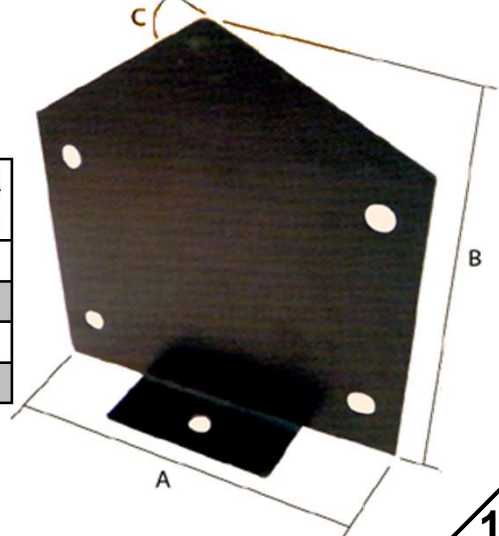

**SOPORTE PARA TECHO**

**MENSULA PARA ESTANTE**

Chapa N° 11 (3 mm.)



| ART.  | MEDIDA |     |    | PRECIO x PAR | CANTIDAD x PAQ. |
|-------|--------|-----|----|--------------|-----------------|
|       | A      | B   | C  |              |                 |
| M-190 | 190    | 90  | 22 | \$ 7.065,40  | 12              |
| M-300 | 300    | 135 | 22 | \$ 17.926,30 | 12              |

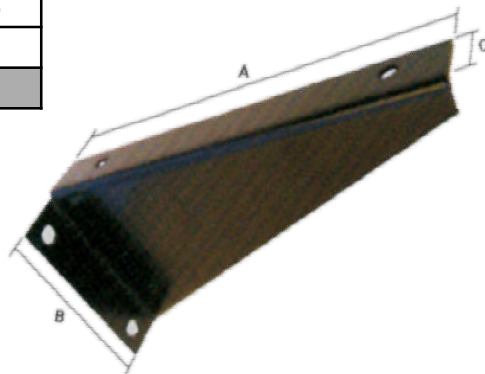

**PLACA DE EMPATILLADO CON PESTAÑA**

Chapa N° 11 (3 mm.)

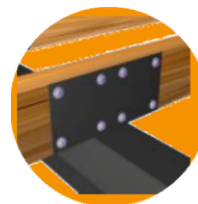

| ART.  | MEDIDA |     |     | PRECIO x Unidad | CANTIDAD x PAQ. |
|-------|--------|-----|-----|-----------------|-----------------|
|       | A      | B   | C   |                 |                 |
| PEP-4 | 20     | 90  | 300 | \$ 6.282,50     | 10              |
| PEP-5 | 20     | 115 | 350 | \$ 8.465,20     | 10              |
| PEP-6 | 20     | 140 | 400 | \$ 11.488,90    | 10              |

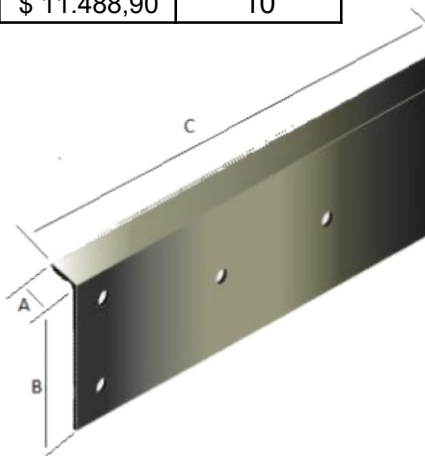

## SOPORTE PARA TECHO

### BASE DE COLUMNA

Chapa N° 11 (3 mm.)

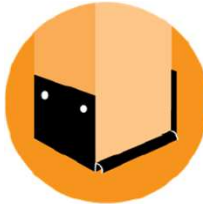

| ART.   | MEDIDA |     |     |    | PRECIO x<br>Unidad | CANTIDA<br>D x PAQ. |
|--------|--------|-----|-----|----|--------------------|---------------------|
|        | A      | B   | C   | D  |                    |                     |
| BC-4X4 | 70     | 95  | 90  | 10 | \$ 9.010,20        | 1                   |
| BC-5X5 | 100    | 120 | 115 | 10 | \$ 12.091,95       | 1                   |
| BC-6X6 | 125    | 145 | 140 | 10 | \$ 17.450,50       | 1                   |
| BC-6X7 | 115    | 162 | 140 | 10 | \$ 20.131,10       | 1                   |
| BC-7X7 | 115    | 170 | 162 | 10 | \$ 29.791,40       | 1                   |

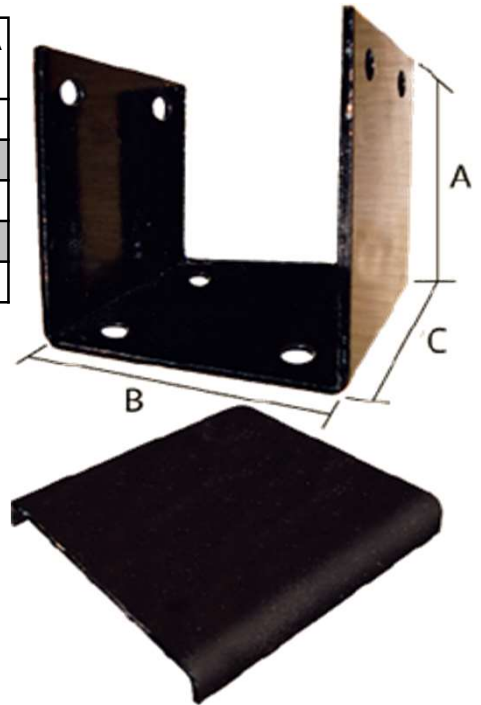

### BASE DE COLUMNA CON PIE

Chapa N° 11 (3 mm.)

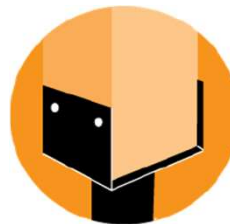

| ART.    | MEDIDA |     |     |     | PRECIO x<br>Unidad | CANTIDA<br>D x PAQ. |
|---------|--------|-----|-----|-----|--------------------|---------------------|
|         | A      | B   | C   | D   |                    |                     |
| BCP-4X4 | 70     | 95  | 90  | 300 | \$ 19.727,20       | 1                   |
| BCP-5X5 | 90     | 120 | 115 | 300 | \$ 26.839,65       | 1                   |
| BCP-6X6 | 125    | 145 | 140 | 300 | \$ 33.669,90       | 1                   |
| BCP-6X7 | 120    | 162 | 140 | 300 | \$ 33.669,90       | 1                   |
| BCP-7X7 | 115    | 170 | 162 | 300 | \$ 38.173,60       | 1                   |

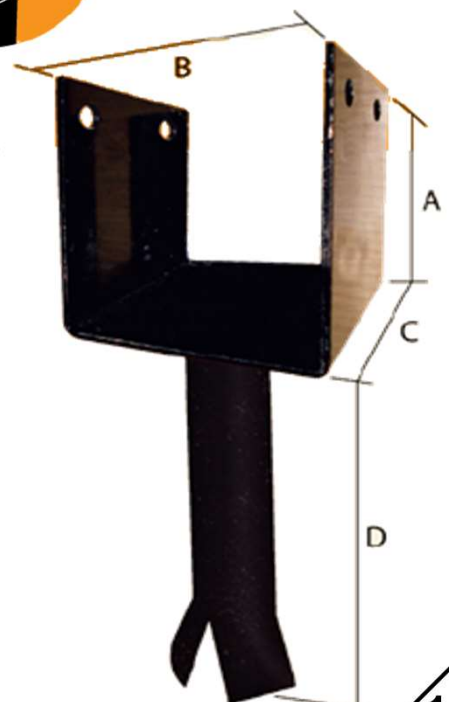



Panama 5945 (1682) M. Coronado-Pci. Bs. As.  
Tel. y Fax 4751-1533 / 9034 - info@fchsa.com.ar

## LISTA DE PRECIOS N° 94

VIGENCIA DESDE EL 02 DE FEBRERO DE 2026

# SOPORTE PARA TECHO

## SOPORTE REDONDO 90°

Chapa N° 14 (2 mm)

| ART.   | MEDIDA |    | PRECIO x<br>Unidad | CANTIDAD<br>x PAQ. |
|--------|--------|----|--------------------|--------------------|
|        | A      | B  |                    |                    |
| SR-100 | 100    | 40 | \$ 3.673,80        | 12                 |
| SR-130 | 130    | 40 | \$ 3.911,70        | 12                 |

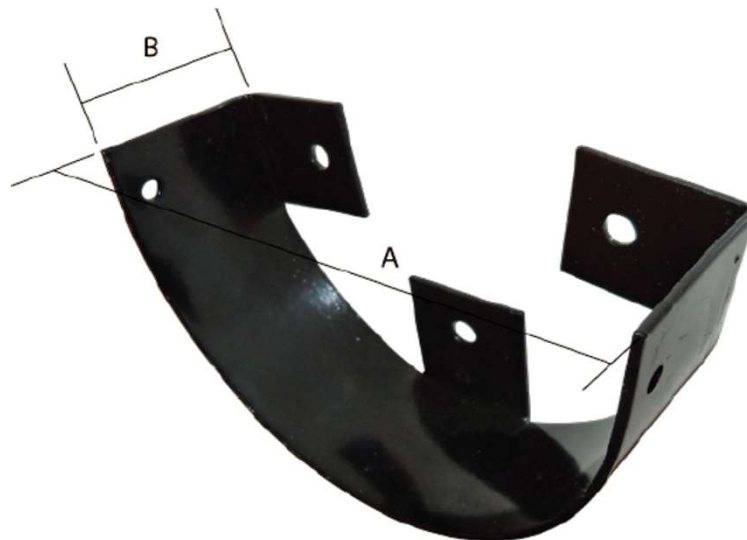

### MATERIAL UTILIZADO

Soportes: Chapa N° 14 (2 mm)

Angulos y Sportes en " L " : Chapa N° 13 (2,5 mm.)

Base de Columna: Chapa N° 11 (3 mm.)

Los precios de la presente lista no incluyen I.V.A., se encuentran sujetos a variación sin previo aviso y registrarán al momento de la entrega sin excepción.

## FICHAS Y B. MUNICION

### FICHA PARA SOLDAR

| ART.            | DESCRIPCION                      | P. UNI.     | X CAJA |
|-----------------|----------------------------------|-------------|--------|
| <b>FS-80X33</b> | Ficha de 80 x 33 mm. Alas Largas | \$ 1.763,75 | 25     |
| <b>FS-80X8</b>  | Ficha de 80 x 8 mm. Alas Cortas  | \$ 1.356,35 | 25     |
| <b>FS-60X33</b> | Ficha de 60 x 33 mm. Alas Largas | \$ 1.476,00 | 25     |
| <b>FS-60X8</b>  | Ficha de 60 x 8 mm. Alas Cortas  | \$ 1.086,05 | 25     |

ART. FS-80x33



ART. FS-80x8

### FICHA PARA ATORNILLAR

| ART.               | DESCRIPCION                                   | P. UNI.     | X CAJA |
|--------------------|---|-------------|--------|
| <b>FA-2X3X1.5</b>  | F. 2x3x1,5 mm. Rev. con tapa y perno M. H. P. | \$ 1.222,40 | 25     |
| <b>FAA-2X3X1.5</b> | F. 2x3x1,5 mm. Rev. con tapa y perno M. Z. A. | \$ 1.466,90 | 25     |
| <b>FAD-2X3X1.5</b> | F. 2x3x1,5 mm. Rev. con tapa y perno M. Z. D. | \$ 1.466,90 | 25     |
| <b>FA-2X5X1.5</b>  | F. 2x5x1,5 mm. Rev. con tapa y perno M. H. P. | \$ 1.380,80 | 25     |
| <b>FAA-2X5X1.5</b> | F. 2x5x1,5 mm. Rev. con tapa y perno M. Z. A. | \$ 1.657,00 | 25     |
| <b>FAD-2X5X1.5</b> | F. 2x5x1,5 mm. Rev. con tapa y perno M. Z. D. | \$ 1.657,00 | 25     |

ART. FAA x 3



ART. FAA x 5



### MUNICION PARA SOLDAR ALA LARGA

| ART.             | DESCRIPCION                                 | P. UNI.     | X CAJA |
|------------------|---|-------------|--------|
| <b>MS-100X75</b> | B. M. para soldar de 100 x 75 mm. Ala Larga | \$ 3.263,00 | 20     |
| <b>MS-75X75</b>  | B. M. para soldar de 75 x 75 mm. Ala Larga  | \$ 2.618,80 | 20     |

ART. MS-100

### MUNICION PARA SOLDAR ALA CORTA

| ART.             | DESCRIPCION                                 | P. UNI.     | X CAJA |
|------------------|---|-------------|--------|
| <b>MS-100X36</b> | B. M. para soldar de 100 x 36 mm. Ala Corta | \$ 2.698,00 | 25     |
| <b>MS-75X36</b>  | B. M. para soldar de 75 x 36 mm. Ala Corta  | \$ 2.060,40 | 25     |



### MUNICION PARA ATORNILLAR

| ART.             | DESCRIPCION                                  | P. UNI.     | X CAJA |
|------------------|--|-------------|--------|
| <b>MA-100X75</b> | B. M. p/at. de 100x75 mm. Ala L. Carp. Z. A. | \$ 3.599,35 | 20     |
| <b>MA-75X75</b>  | B. M. p/at. de 75x75 mm. Ala L. Carp. Z. A.  | \$ 2.770,70 | 20     |



ART. MS-100

ART. MA-100



**SEGURIDAD**

**PINCHES**

| ART.  | BASE       | ALTURA | CANTIDAD       | P. UNI.     | X CAJA |
|-------|------------|--------|----------------|-------------|--------|
| PS-L1 | 14x2,5 mm. | 9 cm.  | 8 Flores x mt. | \$ 6.826,10 | 40     |



**KIT PARA PUERTA CORREDIZA**

| ART.        | MATERIAL | GUIA  | P. UNI.       | X CAJA | DESCRIPCION           |
|-------------|----------|-------|---------------|--------|-----------------------|
| KPG-2       | 32x5 mm. | 2 mts | \$ 71.682,70  | 1      | KIT GRANERO           |
| KPG-3       | 32x5 mm. | 3 mts | \$ 80.994,80  | 1      | KIT GRANERO           |
| CAR(EL PAR) | 32x5 mm. |       | \$ 50.768,35  | 1      | ACC. P/AGREGAR PUERTA |
| KPP-1       | 32x5 mm. | 1 mt  | \$ 95.232,70  | 1      | PUERTA PLEGADIZA      |
| KPP-2       | 32x5 mm. | 1 mt  | \$ 106.959,05 | 1      | PUERTA PLEGADIZA      |
| KPP-3       | 32x5 mm. | 1 mt  | \$ 118.685,40 | 1      | PUERTA PLEGADIZA      |
| KGD-2       | 32x5 mm. | 2 mts | \$ 123.398,35 | 1      | PUERTA SUPERPUESTA    |
| KGD-3       | 32x5 mm. | 3 mts | \$ 132.710,45 | 1      | PUERTA SUPERPUESTA    |

